

Dalle profondità marine a Marte

Celle di carico
Sensori torsione
Sensori pressione
Sensori di forza
Sensori multiassiali
Strumenti
Software
Servizio Calibrazione

Soluzioni per sensori

www.futek.com



Z540-1-1994



9001:2008



17025:2005



13485:2012

RoHS



U.S. Manufacturer



Principali mercati:



Automotive

► pag. 6



Aviazione & Aerospaziale

► pag. 8



Medicina & Farmaceutica

► pag. 10

Altri mercati:



Agricoltura



Automazione



Costruzioni Industriali



Materiale Sicurezza & Test



Robotica



Ingegneria Fluviale

FUTEK Advanced Sensor Technology, Inc. è un produttore statunitense di celle di carico, sensori di coppia, sensori di pressione, sensori multi-assi e di strumenti e software correlati. Situata nel sud della California, FUTEK ha costruito una reputazione come fornitore di qualità di strumenti di test e misura. Specializzata nella ricerca e nello sviluppo di questi dispositivi di rilevamento avanzati, prodotti da FUTEK, sono utilizzati in molte applicazioni industriali, come nella medicina, aerospaziale, auto motive, automazione e robotica. Assicurando di produrre alta qualità in termini di prestazioni e di affidabilità, per tutta la linea dei prodotti FUTEK impareggiabile all'interno dell'industria della misura. Questa guida descrive tutti i nostri prodotti offerti da celle di carico miniatura a quelle a fatica di alte portate, sensori di coppia rotanti. Inoltre, troverete descrizioni dettagliate di soluzioni USB FUTEK, software SENSit di misura e altri strumenti di misura.



Charles Vatcher
U.S. Air Force

"Sono stati utilizzati modelli di celle di carico FUTEK in molte applicazioni di test USAF e hanno eseguito con precisione le misure in modo preciso e affidabile, eccellenti e accurati i test di volo dati ai nostri clienti.

I vostri eccellenti prodotti sono supportati in modo eccellente dal vostro servizio clienti estremamente utile, che va ben oltre al contributo che si aspetta il cliente come il supporto tecnico eccellente e la consegna rapida "



CELLE DI CARICO Pag 12

- ▶ 10g a 1.000.000 lbs campo di misura
- ▶ Miniaturizzazione
- ▶ Uscita amplificata e digitale

SENSORI DI COPPIA Pag 24

- ▶ Da 0,04 Nm a 500.000 Nm
- ▶ Misura torsionale
- ▶ Coppia rotante e velocità (RPM), angolo e potenza

SENSORI PRESSIONE □ Pag 28

- ▶ Raccordi maschi, femmina e a incasso
- ▶ -14.5 PSI fino a 15.000 PSI campo di misura
- ▶ Opzioni amplificatore integrato



SENSORI OEM □ Pag 4

- ▶ Alta qualità, conveniente e rapida consegna
- ▶ Tipo criogenico e amagnetico
- ▶ Ermetico, immergibile, doppio ponte e lavoro a fatica



STRUMENTI □ Pagina 32 •

- ▶ Da pannello e palmare
- ▶ Connessione digitale USB o condizionatore di segnale amplificatore
- ▶ Perfetta integrazione con i sensori

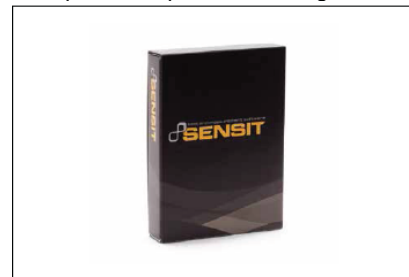

SOFTWARE □ Pagina 35

- ▶ Misura fino a 16 canali
- ▶ Presentazione grafica
- ▶ Acquisizione dei dati

Servizio di calibrazione dei sensori

Offriamo una vasta gamma di servizi di taratura e calibrazione in conformità con ISO / IEC – 17025 standard. Calibrazioni di sistemi completi possono essere eseguite sui nostri sensori accoppiati con uno qualsiasi dei nostri display digitali, soluzioni USB e amplificatori. Questi servizi di taratura sono pienamente accreditati dalla American Association for Laboratory Accreditation (A2LA). Questa certificazione include anche l'accREDITamento di ANSI / NCSL Z540-1-1994.

- Calibrazioni fino a 400.000 lb
- Calibrazioni di coppia fino a 300.000 in-lb
- Calibrazioni di pressione fino a 10.000 PSI

Per saperne di più sui nostri servizi di taratura a:
www.futek.com/calibration-services.aspx





La maggior parte dei produttori può non condividere la nostra posizione in materia di trasparenza, ma noi vogliamo portarvi a conoscere FUTEK prima di ogni formalizzazione. Dopo tutto OEM significa VOI e NOI. La nostra filosofia per lo sviluppo di una partnership OEM è basata sul concetto di apertura e fiducia. Vogliamo che comprendiate le nostre reali competenze, i nostri standard di qualità ed il nostro impegno per la consegna. Ai nostri occhi una partnership OEM è di successo solo quando voi, nostri preziosi clienti, avete successo

Per molte industrie le soluzioni dei sensori OEM sono un elemento integrante del business produttivo. Affidati al tuo produttore OEM per consolidare le tue relazioni commerciali. Alla FUTEK capiamo l'esigenza vitale di trovare soluzioni di sensori che siano una quantità e una convenienza ragionevole. Iniziare un percorso OEM con FUTEK significa lavorare con voi per trovare una soluzione che sia efficiente, ad alta prestazione e a costi convenienti.

Siamo lieti di affermare che i nostri standard qualitativi non cambiano con la produzione delle vostre soluzioni di sensori OEM .

Tutti i nostri sensori OEM sono prodotti a mano presso la nostra sede di Irvine, in California, USA. La produzione in questo stabilimento consente al nostro team di offrire una garanzia sulla qualità, di effettuare diverse verifiche durante il processo di produzione, in modo da garantire che il prodotto finale OEM soddisfi i vostri requisiti e specifiche.

FUTEK e il Committente OEM

- Certificazioni affidabili e accreditamenti
- Prodotto in U.S.A.
- Direttamente dallo stock
- Progettato per l'integrazione del sistema
- Consegna puntuale
- Soluzioni convenienti

OEM Capacità e prestazioni

- Miniaturizzazione
- Protezione da sovraccarico
- Gamma di capacità espansiva
- Fatica nominale
- Composizione Materiale
- Le modifiche e le opzioni di personalizzazione



PRESENTAZIONE DELLE SOLUZIONI DEI SENSORI OEM

Come già detto, il produttore delle tue soluzioni di sensori OEM gioca un ruolo fondamentale nel successo della tua attività. Ecco perché diamo così tanta importanza al periodo di qualificazione.

A tale proposito John Schnell, il nostro capo ingegnere per le applicazioni, ha creato una presentazione di 45 minuti che illustra le linee guida e le domande necessarie per approvare un produttore OEM, per determinarne le aspettative per lo sviluppo di soluzioni OEM, e per trovare i programmi che contribuiranno a creare un rapporto di continuità tra voi e la vostra fonte di soluzione di sensori.

Ti suggeriamo di guardare questa presentazione on-demand e di contattarci per sottoporci qualsiasi ulteriore domanda.

Visualizza il video www.futek.com/videos.aspx

Nel corso degli ultimi 25 anni FUTEK si è costruita una reputazione di un'azienda leader nella fornitura di prodotti di prova e di misura.

Come ogni anno di attività apporta qualcosa a quello successivo, così la nostra squadra si rafforza nella propria esperienza come "fonte di soluzione di sensori".

Le nostre linee di produzione aumentano, le nostre tecnologie diventano sempre più avanzate, e le nostre conoscenze nel mondo

dei test e delle misure diventano inestimabili.

Ma invece che rivendicare questa conoscenza come nostra sola proprietà, abbiamo creato un portale on-line per ingegneri, studenti, ricercatori e altre menti curiose di esplorare le vaste applicazioni in cui poter operare con i nostri prodotti di test e di misura.

Vi invitiamo ad esplorare ciò che è possibile fare con le nostre applicazioni concettuali online



PEDAL FORCE TESTING
▶ page 7

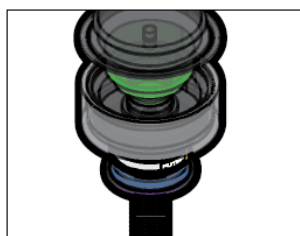

'CURIOSITY' ROVER DRILL
▶ page 8

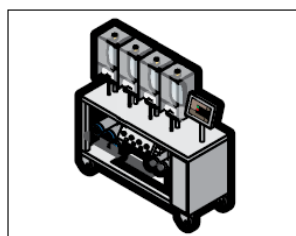

MEDICAL BAG WEIGHING
▶ page 11

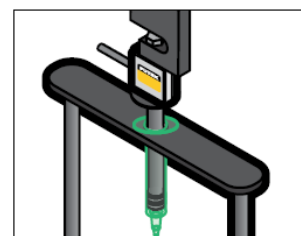

SYRINGE STAND
▶ page 12

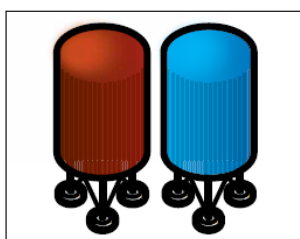

DUAL TANK LEVEL CONTROLLER
▶ page 23



ELECTRIC NUT RUNNER
▶ page 24

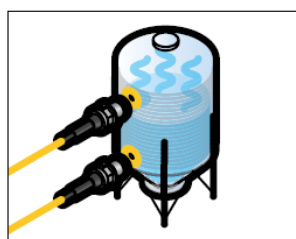

TANK PRESSURE
▶ page 28

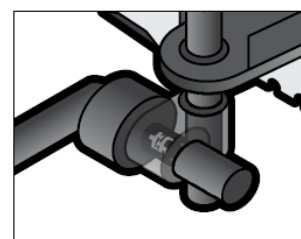

'CURIOSITY' ROVER ARM
▶ page 30



Qualificazione e verifica sono passi sostanziali per i test automotive.

Celle di carico e sensori multiassiali, sono diventati una necessità sia nelle prove di forza di frenata di un veicolo, che in quelle di torsione di un cambio marcia.

Quindi FUTEK ha appositamente progettato una serie di sensori per le applicazioni automotive.

Il prodotti di test e di misura seguenti sono utilizzati principalmente in tali progetti di verifica, ma non sono limitati all'ambiente automotive

LCF400



250, 500, 1K, 2.5, 5K lb.
(1112, 2224, 4K, 11K,
22K N)

- Load Column Tension/Compression**
- Resist high extraneous loads
 - One-piece construction
 - 17-4ph S.S.
 - Bendix receptacle: PT02E-10-6P
 - Optional mating connector: PT06A-10-6S-SR

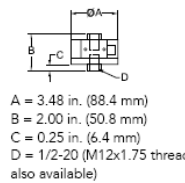

Rated Output: 3 mV/V nom., 250 lb 1.5 mV/V
Nonlinearity: ± 0.1% of RO
Hysteresis: ± 0.1% of RO
Operating Temperature: -65 to 200° F
Excitation (max): 18 VDC
Bridge Resistance: 700 Ω nom.
Deflection: 0.002" nom.
Wiring Code: CC1

LAU220



300, 500 lb.
(1334, 2224 N)

- Spike Resistant Pedal Force Sensor**
- 17-4ph S.S. one-piece construction
 - Low profile, off-center loading error <1%
 - 24 AWG, 4 conductor shielded PVC cable, 15 ft.
 - Detachable mounting plate with hose clamp mounting provision included



Rated Output: 2 mV/V nom.
Nonlinearity: ± 0.25% of RO
Hysteresis: ± 0.25% of RO
Operating Temperature: -60 to 200° F
Excitation (max): 20 VDC
Bridge Resistance: 700 Ω nom.
Deflection: 0.006" nom.
Wiring Code: WC1

LAU300



3K lb.
(13K N)

- Seat Belt Sensor**
- Tests tension forces on seat belts
 - Accepts belts up to 0.1" Thick
 - Titanium sensing element
 - 4-pin Microtech Style Receptacle DR-4S

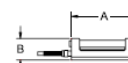

Rated Output: 2 mV/V nom.
Nonlinearity: Contact Factory
Hysteresis: Contact Factory
Operating Temperature: 0 to 200° F
Excitation (max): 18 VDC
Deflection: Contact Factory
Bridge Resistance: 350 Ω nom.
Wiring Code: CC6

MAU300



10, 25, 50, 100, 200 lb.
(44, 111, 222, 445, 890 N)

- Shift Knob Force Sensor**
- Measure Fx and Fy loads
 - Anodized aluminum
 - Ergonomic cover w/ antislip notches
 - 28 AWG, 4 conductor shielded PVC cable, 10 ft. long

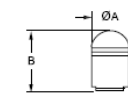

Rated Output: 2 mV/V nom.
Nonlinearity: ± 0.25% of RO*
Hysteresis: ± 0.25% of RO*
Operating Temperature: -40 to 160° F
Excitation (max): 20 VDC
Bridge Resistance: 350 Ω nom.
Deflection: 0.002 to 0.009" nom.
Wiring Code: WC1

TEDS opzione per tutti i modelli a catalogo. Fattori di carico estranei disponibile
Visita www.futek.com oppure contatta il rappresentante locale

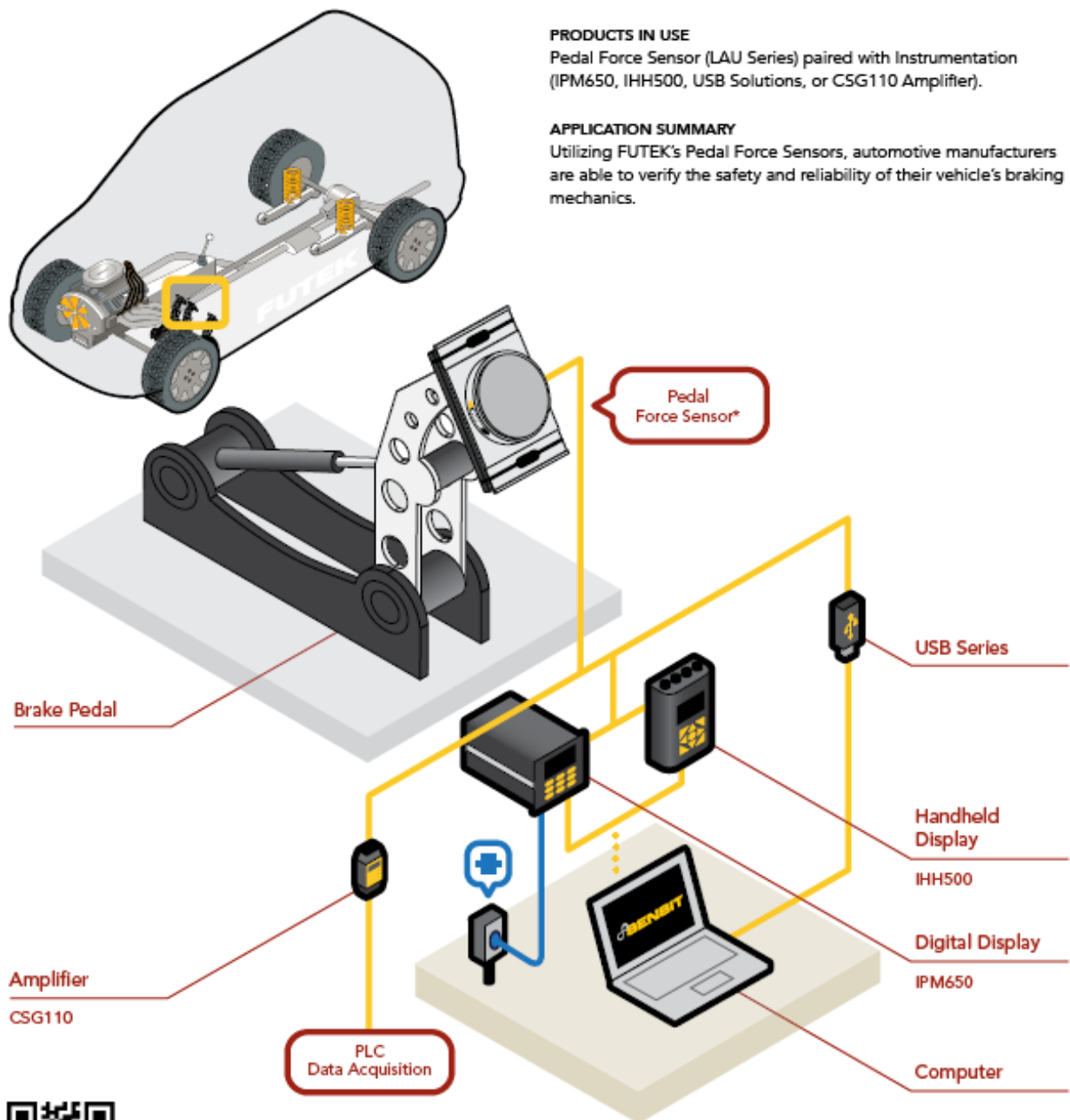

PRODUCTS IN USE

Pedal Force Sensor (LAU Series) paired with Instrumentation (IPM650, IHH500, USB Solutions, or CSG110 Amplifier).

APPLICATION SUMMARY

Utilizing FUTEK's Pedal Force Sensors, automotive manufacturers are able to verify the safety and reliability of their vehicle's braking mechanics.



◀ Read more about this and other automotive applications

- LAU Automotive Load Cells
- USB USB Series
- IHH Hand Held
- CSG Amplifier

* LAU220 version – Spike Resistant ▶ page 12
LAU220 available with round mounting plate



In qualità di azienda di progettazione e di produzione accreditata ISO9001-2008, conforme AS9100, certificata ANSI-Z540 e ISO 17025 A2LA, FUTEK possiede le capacità necessarie per sviluppare celle di carico, sensori di coppia, sensori multiassi e dinamometri per ambienti criogenici e sottovuoto.

Negli ultimi anni NASA, Raytheon, MIT, Lockheed Martin e JPL hanno installato a bordo prodotti FUTEK per diverse iniziative veramente fuori-dal-mondo.

Dalla Stazione Spaziale Internazionale a Marte, FUTEK ha sviluppato nuove tecnologie per resistere agli ambienti sconosciuti che lo spazio ci presenta.

L'esplorazione dello spazio è stata una parte importante della cultura internazionale degli ultimi sessanta anni. Dalle orbite ai satelliti, dalla passeggiata sulla Luna al recente atterraggio su Marte avvenuto con successo, il pubblico di tutto il mondo attende con trepidazione di vedere quale sarà la prossima missione oltre l'atmosfera terrestre.

FUTEK Advanced Sensor Technology ha avuto il privilegio di lavorare su molte di queste acclamate missioni.

Lavorando con la NASA in numerose occasioni, FUTEK ha partecipato a programmi come Orion e la Stazione Spaziale Internazionale iLIDS.

Tuttavia questo è niente in confronto al lavoro svolto per Marte sulla Rover "Curiosity". La realtà è che FUTEK ha due sensori in funzione sul pianeta, sembra quasi surreale.

Molti dei membri del team FUTEK hanno ammirato la NASA per i gli sforzi fatti nell'esplorazione dell'ignoto. Lo sviluppo di una cella di carico criogenica personalizzata (come si vede a sinistra) e di un sensore multiassiale per questa missione, sono state un'occasione monumentale a cui prendere parte.

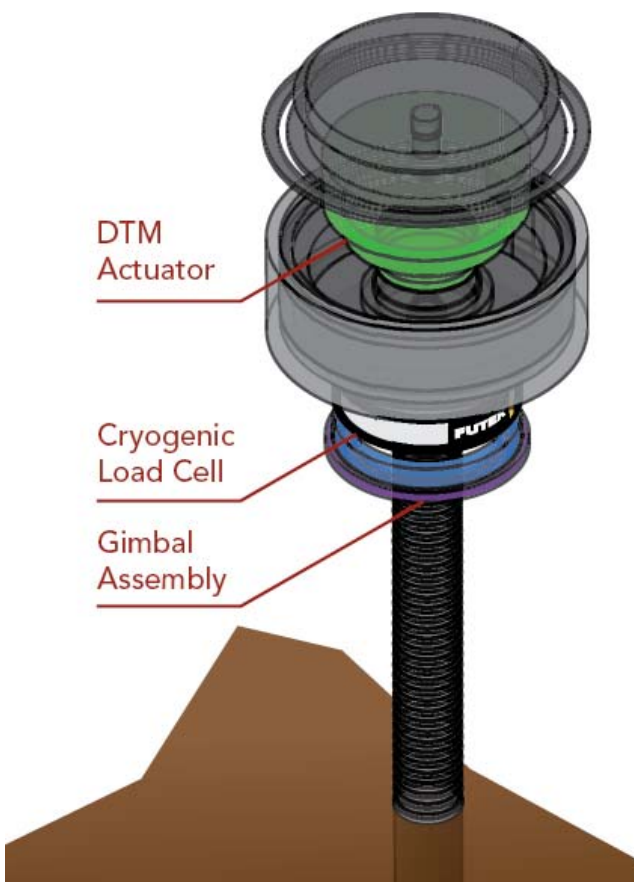

FUTEK ha sviluppato due sensori unici per Marte Rover.

A bordo del "Curiosity" trova posto un sensore multiassiale criogenico per il carico assiale e di torsione responsabile del monitoraggio dei movimenti e delle manovre dei bracci di perforazione e di recupero dei campioni sedimentati da analizzare.

In aggiunta FUTEK ha sviluppato una cella di carico Thru-Hole criogenica in grado di monitorare con estrema precisione la forza usata per eseguire direttamente perforazioni sulla superficie di Marte. Entrambi i sensori sono progettati per operare tutto il giorno a temperature che oscillano tra i 23 °F e si abbassano fino a -124 °F.

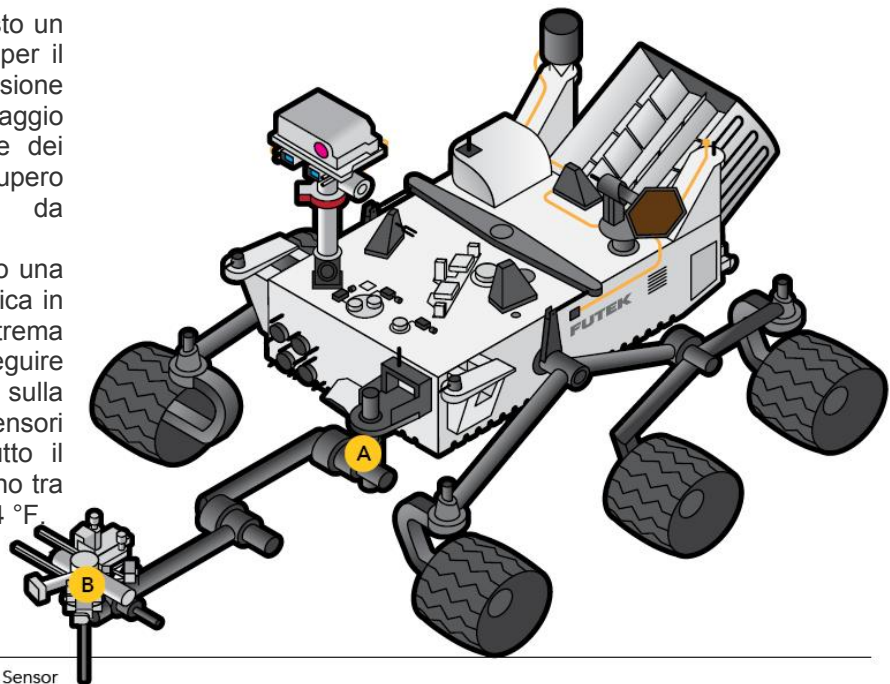

A Cryogenic Multi-Axis Load and Torque Sensor

B Cryogenic Thru-Hole Load Cell

UN SUCCESSO CELEBRATO DALL'INTERA SQUADRA



FUTEK i soci, Javad Mokhbery (sinistra) e Mohammad Mokhberl (destra) presentano uno dei sensori usati su Marte Rover "Curiosity"

La FUTEK Advanced Sensor Technology, Inc. è più che estasiata dalle ultime notizie riguardanti Marte e il Rover Curiosity. Il successo di questa primissima raccolta di campioni inter-planetari non solo ha fatto storia per la NASA e per tutto il programma spaziale degli Stati Uniti, ma anche per FUTEK, in quanto due strumenti di misura erano parte integrante di questa missione di perforazione.

Sei anni fa FUTEK ha collaborato con la NASA JPL allo sviluppo del meccanismo avanzato di perforazione a bordo del Rover.

Con la progettazione e la produzione di due sensori personalizzati per il braccio di perforazione del Rover, i prodotti FUTEK sono responsabili del monitoraggio della forza applicata alla punta della trivella, nonché del monitoraggio della torsione e del carico applicato al braccio di perforazione.

Questi sensori di carico multiassiali customizzati si sincronizzano direttamente ad un sistema di feedback continuo, che notifica al Rover quando la forza massima viene applicata durante queste spedizioni di perforazione.





FUTEK ha integrato con successo i suoi sensori per i test e misura nei più complicati e critici equipaggiamenti robotizzati per interventi chirurgici.

La nostra capacità di fornire soluzioni ingegnerizzate ci permette di realizzare prodotti unici e customizzate su specifica per soddisfare le precise esigenze dei nostri clienti.

L'immagine a fianco presenta il sistema Intuitive "Da Vinci" Surgical®



In qualità di azienda conforme alla norma ISO 13485, i sensori FUTEK sono adatti ad operare in un vasto numero di applicazioni mediche correlate, come la pesatura della sacca di soluzione fisiologica, il controllo del feedback della dialisi e la ricerca comportamentale. La nostra esperienza include lavorazioni con vuoto nominale, non magnetiche, sensori miniaturizzati, così come la conformità alla normativa RoHS.

LMD30050 lb.
(222 N)**Pinch Sensor**

- Used to measure pinch force in medical rehab., lab testing and window pinch force measurement
- Anodized aluminum
- 29 AWG, 4 conductor shielded PVC cable, 10 ft

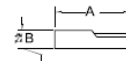
A = 1.54 in. (39.1 mm)
B = 0.55 in. (14.0 mm)

Rated Output: 2 mV/V nom.
Nonlinearity: ± 0.5% of RO
Hysteresis: N/A
Operating Temperature: 0 to 160° F
Excitation (max): 18 VDC
Bridge Resistance: 1000 Ω nom.
Deflection: 0.005" nom.
Wiring Code: WC1

LSB2000.35 oz., 0.71 oz., 1.76 oz.,
3.5 oz., 8.8 oz., 1, 2, 5, 10,
25, 50, 100 lb.
(10g, 20g, 50g, 100g,
250g; 4, 9, 22, 44, 111,
222, 445 N)**S-Beam Jr. Load Cell**

- In-line loading in compression/tension
- Built-in overload protection
- 2024 aluminum, 17-4ph S.S. (25–100 lb.)
- 29 AWG, 4 conductor shielded silicone cable, 5 ft
- Metric threads available (M3x0.5)

A = 0.68 in. (17 mm)
B = 0.25 in. (6.4 mm)
C = 0.75 in. (19 mm)
D = #4-40 (M3x0.5)
Metric Thread: D = M3x0.5

Rated Output: 0.5 - 2 mV/V nom.
Nonlinearity: ± 0.1% of RO*
Hysteresis: ± 0.1% of RO*
Operating Temperature: -60 to 200° F
Excitation (max): 10 VDC
Bridge Resistance: 350 Ω nom.
Deflection: 0.004 to 0.001" nom.
Wiring Code: WC1

LSM3002.2, 5, 10, 25, 50, 100, 200,
500 lb.
(9.8, 22, 44, 111, 222, 445,
890, 2224 N)**Parallelogram OEM Load Cell**

- Built-in overload protection.
- Side mounted
- Used in tension/compression
- 2024 aluminum, 17-4ph S.S. (200–500 lb.)
- 29 AWG, 4 color coded Teflon® lead wires, 6" standard

A = 1.80 in. (45.7 mm)
B = 0.50 in. (12.7 mm)
C = 1.40 in. (35.6 mm)
D = #10-32, 1/4-28

Rated Output: 2 mV/V nom.
Nonlinearity: ± 0.02% to ± 0.06% of RO*
Hysteresis: ± 0.02% to ± 0.06% of RO*
Operating Temperature: -60 to 200° F
Excitation (max): 18 VDC
Bridge Resistance: 1000 Ω nom.
Deflection: 0.006" nom.
Wiring Code: WC2

TEDS opzione per tutti i modelli a catalogo. Fattori di carico estranei disponibile
Visita www.futek.com oppure contatta il rappresentante locale

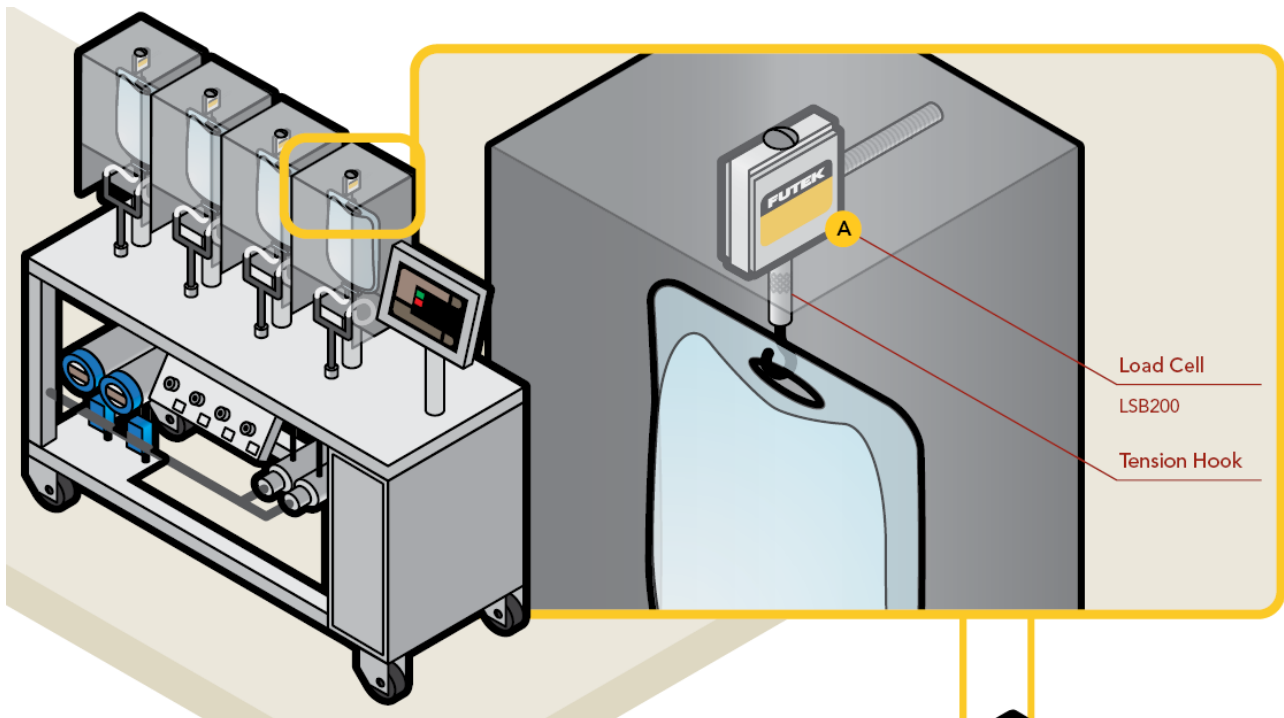

Load Cell
LSB200
Tension Hook



A S-BEAM JR. LOAD CELL
LSB200 ▶ page 10



B HANDHELD DISPLAY
IHH500 ▶ page 34



C USB CONNECTION KIT
USB210 ▶ page 33

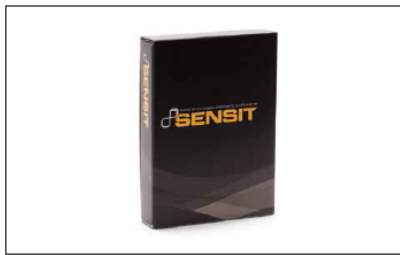

D SENSIT SOFTWARE
ASW200 ▶ page 35

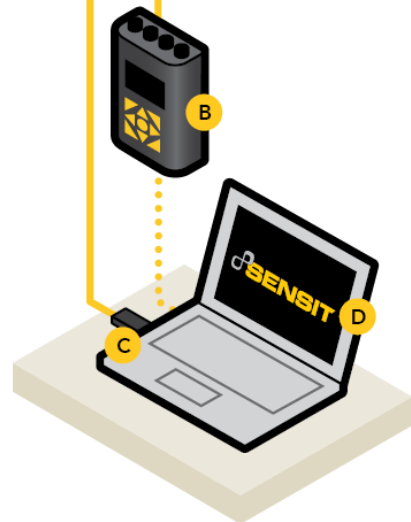

Read more about this and other medical applications for FUTEK products ▼



- LLB** Miniature Load Button
- ASW** Software
- USB** USB Series
- IHH** Handheld Display

TEDS opzione per tutti i modelli a catalogo. Fattori di carico estranei disponibile
Visita www.futek.com oppure contatta il rappresentante locale



FUTEK progetta e sviluppa celle di carico e sensori di forza da 25 anni.

Grazie alla lunga vita di questa linea di prodotti, siamo in grado di offrire molte varianti alle stesse, come esempio a bottone, con foro passante, travi ad S e altro.

Con un magazzino ben fornito di modelli standard, in grado di misurare le forze sia in tensione che in compressione, trovare un sensore per la vostra soluzione g per voi è molto semplice.

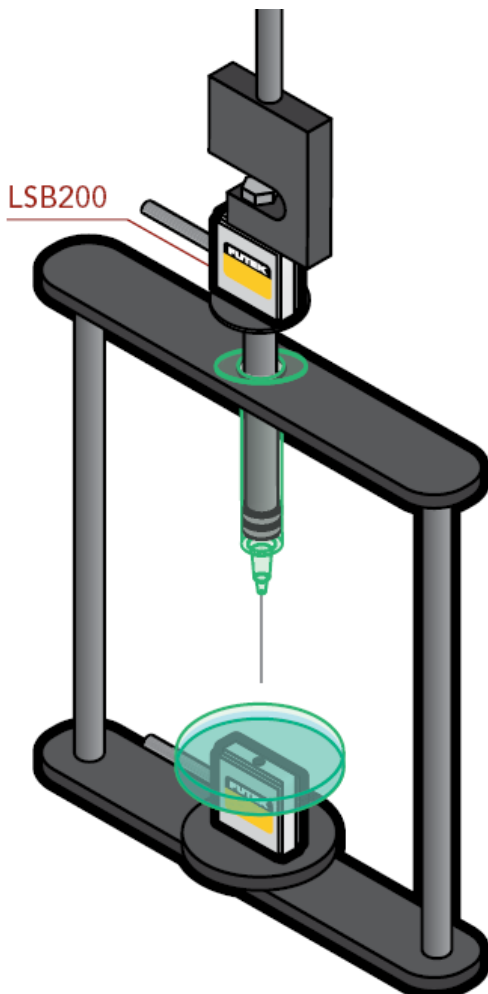

SENSORI DI FORZA PER L'INDUSTRIA

I prodotti standard FUTEK, i prodotti personalizzati e le serie OEM forniscono diverse soluzioni per il settore aerospaziale, medico, automobilistico e per le industrie manifatturiere, tanto per citarne alcune. Questi sensori di carico offrono soluzioni per applicazioni che richiedono sia una misurazione di tensione che di compressione e una varietà di assortimento che spazia dai 10 grammi a un milione di libbre.

Disegni a catalogo

- Trave a "S"
- Bottone
- Colonna / Incamiciata
- Pancake
- Giunti sferico
- Allineata
- Foro passante
- Allineata

FUTEK offre una serie di soluzioni customizzate:

- Criogenica
- Fatica nominale
- Miniatura
- Spazio / Volo Qualificazione
- Immersibile
- Amagnetico
- Doppio ponte
- Alta temperatura



Visualizza il video www.futek.com/videos.aspx

Miniatura a “S” (LSB200)

La cella di carico miniaturizzata a “S”. è in grado di misurare forze in compressione e trazione da 10 gr a 444 N.

Il formato miniaturizzato di LSB200 e l’eccezionale capacità di protezione da sovraccarico rendono questo modello molto adattabile all’interno delle varie applicazioni industriali.

Le seguenti caratteristiche sono aggiuntive a semplificazione della versatilità della LSB200:

- OEM
- Immersibile
- Sotto vuoto
- Amagnetico
- Tolleranza alle radiazioni
- Alta temperatura

FUTEK ha una vasta gamma di celle di carico miniaturizzate per misurazioni sia di trazione che di compressione.

Con una capacità di insieme che spazia da 10 grammi a 20.000 libbre forza, queste celle di carico sono adatte ad applicazioni che richiedono alta precisione ed alta resistenza.



S-BEAM JR. LOAD CELL
LSB200 ► page 20



S-BEAM JR. WITH MALE THREAD
LRM200 ► page 20

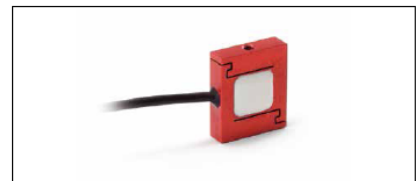

SUBMERSIBLE S-BEAM JR. LOAD CELL
LSB210 ► page 21



SUBMINIATURE LOAD BUTTON
LLB130 ► page 18



SUBMINIATURE THREADED LOAD BUTTON
LLB210 ► page 18



SUBMINIATURE LOAD BUTTON
LLB300 ► page 18



SUBMINIATURE IN-LINE LOAD CELL
LCM200 ► page 17













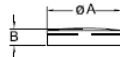

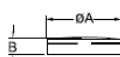

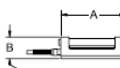
MINIATURE IN-LINE LOAD CELL
LCM300 ► page 17



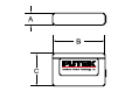

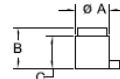
DONUT LOAD CELL
LTH300 ► page 19

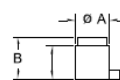
- LTH** Thru-Hole/Donut
- LLB** Rectangular Female/Female
- LRM** Rectangular Male/Male
- LSB** S-Beam/Z-Beam

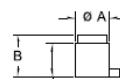
TEDS opzione per tutti i modelli a catalogo. Fattori di carico estranei disponibile
Visita www.futek.com oppure contatta il rappresentante locale

MODEL #	CAPACITIES	DESCRIPTION	DIMENSIONS	SPECIFICATIONS
LAU200 	100, 300 lb. (445, 1334 N)	Accelerator Pedal Force Sensor <ul style="list-style-type: none"> • 17-4ph S.S. one-piece construction • Low profile, off-center loading error <3-4% • Lemo® mating with 10 ft PVC cable assembly included • Detachable mounting plate with hose clamp mounting provision included 	 A = 1.98 in. (50.3 mm) B = 0.38 in. (9.7 mm)	Rated Output: 2 mV/V nom. Nonlinearity: ± 0.2% of RO Hysteresis: ± 0.2% of RO Operating Temperature: -60 to 200° F Excitation (max): 20 VDC Bridge Resistance: 700 Ω nom. Deflection: 0.005-0.009" nom. Wiring Code: CC4, WC1
LAU220 	300, 500 lb. (1334, 2224 N)	Spike Resistant Pedal Force Sensor <ul style="list-style-type: none"> • 17-4ph S.S. one-piece construction • Low profile, off-center loading error <1% • 24 AWG, 4 conductor shielded Teflon® cable, 10 ft • Detachable mounting plate with hose clamp mounting provision included 	 A = 2.58 in. (65.5 mm) B = 0.65 in. (16.5 mm)	Rated Output: 2 mV/V nom. Nonlinearity: ± 0.25% of RO Hysteresis: ± 0.25% of RO Operating Temperature: -60 to 200° F Excitation (max): 20 VDC Bridge Resistance: 700 Ω nom. Deflection: 0.006" nom. Wiring Code: WC1
LAU300 	3K lb. (13K N)	Seat Belt Sensor <ul style="list-style-type: none"> • Tests tension forces on seat belts • Accepts belts up to 0.1" Thick • Titanium sensing element • 4-pin Microtech Style Receptacle DR-4S 	 A = 2.81 in. (71.4 mm) B = 0.80 in. (20.3 mm)	Rated Output: 2 mV/V nom. Nonlinearity: Contact Factory Hysteresis: Contact Factory Operating Temperature: 0 to 200° F Excitation (max): 18 VDC Deflection: Contact Factory Bridge Resistance: 350 Ω nom. Wiring Code: CC6
LMD300 	50 lb. (222 N)	Pinch Sensor <ul style="list-style-type: none"> • Used to measure pinch force in medical rehab., lab testing and window pinch force measurement • Anodized aluminum • 28 AWG, 4 conductor shielded PVC cable, 10 ft 	 A = 1.54 in. (39.1 mm) B = 0.55 in. (14.0 mm)	Rated Output: 2 mV/V nom. Nonlinearity: ± 0.5% of RO Hysteresis: N/A Operating Temperature: 0 to 160° F Excitation (max): 18 VDC Bridge Resistance: 1000 Ω nom. Deflection: 0.005" nom. Wiring Code: WC1
LMD500 	300 lb. (1334 N)	Hand Gripper <ul style="list-style-type: none"> • One piece aluminum construction • Can be used in rehab therapy and as an auditing hand tool 	 A = 0.63 in. (15.9 mm) B = 2.78 in. (70.6 mm) C = 1.73 in. (43.9 mm)	Rated Output: 3 mV/V nom. Nonlinearity: ± 0.25% of RO Hysteresis: ± 0.25% of RO Operating Temperature: -60 to 200° F Excitation (max): 18 VDC Bridge Resistance: 350 Ω nom. Deflection: 0.002" nom. Wiring Code: WC1, CC4
LCA300 	2K, 3K, 5K lb. (9K, 13K, 22K N)	Miniature Load Column <ul style="list-style-type: none"> • 17-4ph S.S. • 29 AWG, 4 conductor shielded Teflon® cable, 10 ft • Small profile for tight spaces • Column design with spherical radiused top • Minimum Natural Frequency 35kHz 	 A = 0.62 in. (15.9 mm) B = 0.65 in. (16.5 mm) C = 0.59 in. (15.0 mm)	Rated Output: 1.3-2 mV/V nom. Nonlinearity: ± 1% of RO Hysteresis: ± 1% of RO Operating Temperature: -60 to 200° F Excitation (max): 18 VDC Bridge Resistance: 350 Ω nom. Deflection: 0.002" nom. Wiring Code: WC1
LCA305 	7.5K, 10K lb. (33K, 44K N)	Miniature Load Column <ul style="list-style-type: none"> • 17-4ph S.S. • 29 AWG, 4 conductor shielded Teflon® cable, 10 ft • Small profile for tight spaces • Column design with spherical radiused top • Minimum Natural Frequency 44kHz 	 A = 0.88 in. (22.4 mm) B = 0.88 in. (22.4 mm) C = 0.77 in. (19.6 mm)	Rated Output: 1.5-2 mV/V nom. Nonlinearity: ± 1% of RO Hysteresis: ± 1% of RO Operating Temperature: -60 to 200° F Excitation (max): 18 VDC Bridge Resistance: 350 Ω nom. Deflection: 0.001" nom. Wiring Code: WC1
LCA310 	15K, 20K, 30K lb. (67K, 89K, 133K N)	Miniature Load Column <ul style="list-style-type: none"> • 17-4ph S.S. • 29 AWG, 4 conductor shielded Teflon® cable, 10 ft • Small profile for tight spaces • Column design with spherical radiused top • Minimum Natural Frequency 22kHz 	 A = 1.25 in. (31.8 mm) B = 1.13 in. (28.7 mm) C = 1.06 in. (26.9 mm)	Rated Output: 1.3-2 mV/V nom. Nonlinearity: ± 1% of RO Hysteresis: ± 1% of RO Operating Temperature: -60 to 200° F Excitation (max): 18 VDC Bridge Resistance: 350 Ω nom. Deflection: 0.004" nom. Wiring Code: WC1











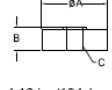

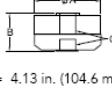
TEDS opzione per tutti i modelli a catalogo. Fattori di carico estranei disponibile
 Visita www.futek.com oppure contatta il rappresentante locale

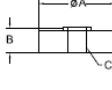
MODEL #	CAPACITIES	DESCRIPTION	DIMENSIONS	SPECIFICATIONS
 LCA600	100K, 200K, 300K lb. (444.8K, 889.6K, 1334K N)	High Capacity Load Column • Canister/Column Load Cell Design • High Capacity – Small Package Size • Strain Gauge Based • Handle for easy carrying • 6-pin Bendix Connector PT02E-10-6P with removable connector guard	 A = 4.00 in. (101.0 mm) B = 6.00 in. (152.4 mm) C = 5.70 in. (143.5 mm)	Rated Output:..... 1.3-2 mV/V nom. Nonlinearity:..... ± 0.25% of RO Hysteresis:..... ± 0.25% of RO Operating Temperature:..... 0 to 160° F Excitation (max):..... 20 VDC Bridge Resistance:..... 350 Ω nom. Deflection:..... 0.01" nom. Wiring code:..... CC1
 LCA700	500K, 750K, 1000K lb. (2224K, 3336K, 4448K N)	High Capacity Load Column • 17-4ph S.S. • Canister/Column Load Cell Design • High Capacity – Small Package Size • Strain Gauge Based • Handle for easy carrying • 6-pin Bendix Connector PT02E-10-6P with removable connector guard	 A = 5.98 in. (151.9 mm) B = 8.00 in. (203.2 mm) C = 7.25 in. (184.2 mm)	Rated Output:..... 2-3 mV/V nom. Nonlinearity:..... ± 0.25% of RO Hysteresis:..... ± 0.25% of RO Operating Temperature:..... -0 to 160° F Excitation (max):..... 20 VDC Bridge Resistance:..... 350 Ω nom. Deflection:..... 0.01" nom. Wiring code:..... CC1
 LCB200	1K, 2K, 3K lb. (4K, 9K, 13K N)	Rod End Tension/Compression • 17-4ph S.S., male/female threads • 28 AWG, 4 conductor shielded PVC cable, 10 ft Teflon® cable optional • External matched output option available	 A = 0.96 in. (24.4 mm) B = 2.00 in. (50.8 mm) C = 1.00 in. (25.4 mm) D = 3/8-24	Rated Output:..... 1-3 mV/V nom. Nonlinearity:..... ± 0.5% of RO Hysteresis:..... ± 0.5% of RO Operating Temperature:..... -45 to 200° F Excitation (max):..... 18 VDC Bridge Resistance:..... 1000 Ω nom. Deflection:..... 0.001" nom. Wiring Code:..... WC1
 LCB400	1K, 2K, 3K, 5K, 10K lb. (4K, 9K, 13K, 22K, 44K N)	Rod End Tension/Compression • 2024 aluminum (1K, 2K lb.) • 17-4ph S.S. (3K, 5K, 10K lb.) • Male/female thread • Bendix receptacle: PT02E-10-6P • Optional mating connector: PT06A-10-6S-SR	 A = 2.20 in. (56.3 mm) B = 4.30 in. (109.0 mm) C = 3/4-16	Rated Output:..... 2 mV/V nom. Nonlinearity:..... ± 0.5% of RO Hysteresis:..... ± 0.5% of RO Operating Temperature:..... -60 to 200° F Excitation (max):..... 18 VDC Bridge Resistance:..... 350 Ω nom. Deflection:..... 0.001" nom. Wiring Code:..... CC1
 LCB450	5K, 10K, 20K lb. (22K, 44K, 89K N)	Rod End Tension/Compression • 17-4ph S.S. • Male/female thread • Bendix receptacle: PT02E-10-6P • Optional mating connector: PT06A-10-6S-SR • Fatigue rated	 A = 2.57 in. (65.2 mm) B = 4.50 in. (114.3 mm) C = 1-14	Rated Output:..... 2 mV/V nom. Nonlinearity:..... ± 0.5% of RO Hysteresis:..... ± 0.5% of RO Operating Temperature:..... -60 to 200° F Excitation (max):..... 18 VDC Bridge Resistance:..... 350 Ω nom. Deflection:..... 0.002" nom. Wiring Code:..... CC1
 LCB500	100, 200, 500, 1K, 2K, 3K, 5K lb. (44.5, 89, 222.4, 4K, 9K, 13K, 22K N)	Rod End Tension/Compression • In-line loading. Ideal for endurance testing. • 17-4ph S.S. • Bendix receptacle: PT02E-10-6P • Optional mating connector: PT06A-10-6S-SR. • One piece construction.	 A = 2.84 in. (72.1 mm) B = 1.63 in. (41.4 mm) C = 1/2-20	Rated Output:..... 0.75-1.5 mV/V nom. Nonlinearity:..... ± 0.25% of RO Hysteresis:..... ± 0.25% of RO Operating Temperature:..... 0 to 200° F Excitation (max):..... 18 VDC Bridge Resistance:..... 700 Ω nom. Deflection:..... 0.002" nom. Wiring Code:..... CC1
 LCF300	10, 25, 50, 100, 250, 500 lb. (44, 111, 222, 445, 1112, 2224 N)	Load Column Tension/Compression • In-line tension/compression with female/female threads • One-piece construction, light weight • 2024 aluminum & 17-4ph S.S. • Lemo® 4 pin receptacle (standard) • Bendix receptacle: PT02E-10-6P (optional) • Optional mating connector: PT06A-10-6S-SR	 A = 1.98 in. (50.3 mm) B = 1.75 in. (44.5 mm) C = 0.19 in. (4.8 mm) D = 1/4-28	Rated Output:..... 1-2 mV/V nom. Nonlinearity:..... ± 0.25% of RO Hysteresis:..... ± 0.25% of RO Operating Temperature:..... -60 to 200° F Excitation (max):..... 20 VDC Bridge Resistance:..... 700 Ω nom. Deflection:..... 0.002" nom. Wiring Code:..... CC4
 LCF400	250, 500, 1K, 2.5, 5K lb. (1112, 2224, 4K, 11K, 22K N)	Load Column Tension/Compression • Resist high extraneous loads • One-piece construction • 17-4ph S.S. • Bendix receptacle: PT02E-10-6P • Optional mating connector: PT06A-10-6S-SR	 A = 3.48 in. (88.4 mm) B = 2.00 in. (50.8 mm) C = 0.25 in. (6.4 mm) D = 1/2-20 (M12x1.75 thread also available)	Rated Output:..... 3 mV/V nom., 250 lb 1.5 mV/V Nonlinearity:..... ± 0.1% of RO Hysteresis:..... ± 0.1% of RO Operating Temperature:..... -65 to 200° F Excitation (max):..... 18 VDC Bridge Resistance:..... 700 Ω nom. Deflection:..... 0.002" nom. Wiring Code:..... CC1

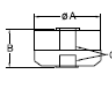
LAU Automotive
LMD Medical
LCA Canister

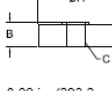
LCB Cylindrical Male/Female
LCF Cylindrical Female/Female

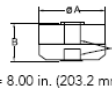

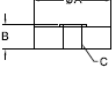









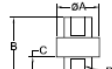

TEDS opzione per tutti i modelli a catalogo. Fattori di carico estranei disponibile
Visita www.futek.com oppure contatta il rappresentante locale

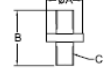
MODEL #	CAPACITIES	DESCRIPTION	DIMENSIONS	SPECIFICATIONS
LCF450 	300, 500, 1K, 2K, 5K, 10K lb. (1334, 2224, 4K, 9K, 22K, 44K N)	Low-Profile Universal Pancake Load Cell <ul style="list-style-type: none"> Anodized Aluminum (500-2K lb); 17-4ph S.S. (300, 5K-10K lb) Bendix receptacle: PT02E-10-6P Optional mating connector: PT06A-10-6S-SR Optional <ul style="list-style-type: none"> Fatigue rate (LCF451) ±0.05% nonlinearity TEDS IEEE1451.4 High temperature 	 A = 4.12 in. (104.6 mm) B = 1.37 in. (34.8 mm) *C = 5/8-18 (M16x2 Metric threads also available)	Rated Output: 2 mV/V nom. Nonlinearity: ± 0.1% of RO* Hysteresis: ± 0.2% of RO* Operating Temperature: -60 to 200° F Excitation (max): 20 VDC Bridge Resistance: 700 Ω nom. Deflection: 0.002" nom. Wiring Code: CC1
LCF455 	300, 500, 1K, 2K, 5K, 10K lb. (1334, 2224, 4K, 9K, 22K, 44K N)	Pancake Load Cell with Tension Base <ul style="list-style-type: none"> In-line loading for compression/tension Anodized Aluminum (500-2K lb); 17-4ph S.S. (300, 5K-10K lb) Bendix receptacle: PT02E-10-6P Amplified version available Fatigue rated version available (LCF456) 	 A = 4.13 in. (104.6 mm) B = 2.50 in. (63.4 mm) C = 5/8-18 (M16x2)	Rated Output: 2 mV/V nom. Nonlinearity: ± 0.1% of RO* Hysteresis: ± 0.2% of RO* Operating Temperature: -60 to 200° F Excitation (max): 20 VDC Bridge Resistance: 700 Ω nom. Deflection: 0.002" nom. Wiring Code: CC1
LCF500 	25K, 50K lb. (111K, 222K N)	Low-Profile Universal Pancake Load Cell <ul style="list-style-type: none"> In-line loading for compression/tension 17-4ph S.S. Bendix receptacle: PT02E-10-6P with removable connector guard Amplified version available Fatigue rated version available (LCF501) Optional <ul style="list-style-type: none"> Dual bridge Dual range TEDS IEEE1451.4 	 A = 5.98 in. (151.9 mm) B = 1.75 in. (44.5 mm) C = 1 1/4-12 (M33x2)	Rated Output: 4 mV/V nom. Nonlinearity: ± 0.1% of RO* Hysteresis: ± 0.2% of RO* Operating Temperature: -60 to 200° F Excitation (max): 20 VDC Bridge Resistance: 350 Ω nom. Deflection: 0.002" nom. Wiring Code: CC1, CC1T
LCF505 	25K, 50K lb. (111K, 222K N)	Pancake Load Cell with Tension Base <ul style="list-style-type: none"> In-line loading for compression/tension 17-4ph S.S. Bendix receptacle: PT02E-10-6P with removable connector guard Amplified version available Fatigue rated version available (LCF506) 	 A = 5.98 in. (151.9 mm) B = 3.50 in. (88.9 mm) C = 1 1/4-12 (M33x2)	Rated Output: 4 mV/V nom. Nonlinearity: ± 0.1% of RO* Hysteresis: ± 0.2% of RO* Operating Temperature: -60 to 200° F Excitation (max): 20 VDC Bridge Resistance: 350 Ω nom. Deflection: 0.002" nom. Wiring Code: CC1
LCF550 	100K lb. (445 K N)	Low-Profile Universal Pancake Load Cell <ul style="list-style-type: none"> In-line loading for compression/tension 17-4ph S.S. Bendix receptacle: PT02E-10-6P with removable connector guard Amplified version available Fatigue rated version available (LCF551) Optional <ul style="list-style-type: none"> Dual bridge TEDS IEEE1451.4 	 A = 8.00 in. (203.2 mm) B = 2.50 in. (63.5 mm) C = 1 3/4-12 (M42x2)	Rated Output: 4 mV/V nom. Nonlinearity: ± 0.1% of RO* Hysteresis: ± 0.2% of RO* Operating Temperature: -60 to 200° F Excitation (max): 20 VDC Bridge Resistance: 350 Ω nom. Deflection: 0.002" nom. Wiring Code: CC1
LCF555 	100K lb. (445 K N)	Pancake Load Cell with Tension Base <ul style="list-style-type: none"> In-line loading for compression/tension 17-4ph S.S. Bendix receptacle: PT02E-10-6P with removable connector guard Amplified version available Fatigue rated version available (LCF556) 	 A = 8.00 in. (203.2 mm) B = 4.50 in. (114.3 mm) C = 1 3/4-12 (M42x2)	Rated Output: 4 mV/V nom. Nonlinearity: ± 0.1% of RO* Hysteresis: ± 0.2% of RO* Operating Temperature: -60 to 200° F Excitation (max): 20 VDC Bridge Resistance: 350 Ω nom. Deflection: 0.002" nom. Wiring Code: CC1
LCF650 	250K lb. (1112 K N)	Low-Profile Universal Pancake Load Cell <ul style="list-style-type: none"> In-line loading for compression/tension 17-4ph S.S. Bendix receptacle: PT02E-10-6P with removable connector guard Amplified version available Fatigue rated version available (LCF651) Optional <ul style="list-style-type: none"> Dual bridge TEDS IEEE1451.4 	 A = 11.00 in. (279.4 mm) B = 3.50 in. (88.9 mm) C = 2 3/4-8 (M72x2)	Rated Output: 4 mV/V nom. Nonlinearity: ± 0.1% of RO* Hysteresis: ± 0.2% of RO* Operating Temperature: -60 to 200° F Excitation (max): 20 VDC Bridge Resistance: 350 Ω nom. Deflection: 0.005" nom. Wiring Code: CC1

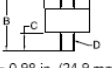
Versioni ad elevata accuratezza

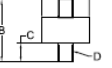

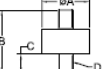

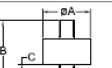





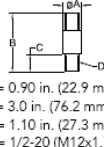

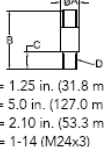

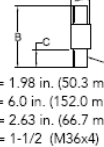
TEDS opzione per tutti i modelli a catalogo. Fattori di carico estranei disponibile

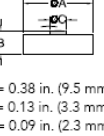
Visita www.futek.com oppure contatta il rappresentante locale

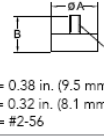

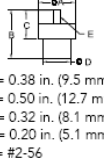

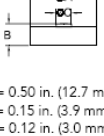

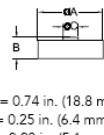







MODEL #	CAPACITIES	DESCRIPTION	DIMENSIONS	SPECIFICATIONS
LCF655 	250K lb. (1112 K N)	Pancake Load Cell with Tension Base <ul style="list-style-type: none"> In-line loading for compression/tension 17-4ph S.S. Bendix receptacle: PT02E-10-6P with removable connector guard Amplified version available Fatigue rated version available (LCF656) 	 A = 11.00 in. (279.4 mm) B = 7.00 in. (177.8 mm) C = 2 3/4-8 (M72x2)	Rated Output:..... 4 mV/V nom. Nonlinearity:..... ± 0.1% of RO* Hysteresis:..... ± 0.2% of RO* Operating Temperature:..... -60 to 200° F Excitation (max):..... 20 VDC Bridge Resistance:..... 350 Ω nom. Deflection:..... 0.005" nom. Wiring Code:..... CC1
LCF700 	400K lb. (1779 K N)	Low-Profile Universal Pancake Load Cell <ul style="list-style-type: none"> In-line loading for compression/tension 17-4ph S.S. Bendix receptacle: PT02E-10-6P with removable connector guard Amplified version available Fatigue rated version available (LCF701, LCF706) Optional <ul style="list-style-type: none"> Dual bridge TEDS IEEE1451.4 	 A = 12 in. (305.0 mm) B = 4.50 in. (114.3 mm) C = 3 1/2-8 (M90x3)	Rated Output:..... 4 mV/V nom. Nonlinearity:..... ± 0.2% of RO* Hysteresis:..... ± 0.2% of RO* Operating Temperature:..... -60 to 200° F Excitation (max):..... 20 VDC Bridge Resistance:..... 350 Ω nom. Deflection:..... Contact factory Wiring Code:..... CC1
LCF800 	50K, 100K, 150K lb. (222K, 445K, 667K N)	Rod End Load Cell (female threads) <ul style="list-style-type: none"> In-line loading for compression/tension 17-4ph S.S. 28 AWG, 6 conductor shielded polyurethane cable, 10 ft 	 A = 3.23 in. (82.0 mm) B = 7.50 in. (191.0 mm) C = 3.0 in. (76.2 mm) D = 1 1/2-12	Rated Output:..... 2 mV/V nom. Nonlinearity:..... ± 0.25% of RO Hysteresis:..... ± 0.25% of RO Operating Temperature:..... -45 to 200° F Excitation (max):..... 20 VDC Bridge Resistance:..... 350 Ω nom. Deflection:..... 0.01" nom. Wiring Code:..... WC4, CC1
LCM200 	250, 500, 1K lb. (1112, 2224, 4K N)	SubMiniature In-Line Load Cell <ul style="list-style-type: none"> Used in compression/tension 17-4ph S.S. 29 AWG, 4 conductor shielded Teflon® cable, 10 ft External matched output option available 	 A = 0.80 in. (20.3 mm) B = 1.20 in. (29.8 mm) C = 3/8-24	Rated Output:..... 1 - 2 mV/V nom. Nonlinearity:..... ± 0.5% of RO Hysteresis:..... ± 0.5% of RO Operating Temperature:..... -60 to 285° F Excitation (max):..... 15 VDC Bridge Resistance:..... 350 Ω nom. Deflection:..... 0.001" nom. Wiring Code:..... WC1
LCM300 	50, 100, 250, 500, 1K lb. (222, 445, 1112, 2224, 4K N)	Miniature In-Line Load Cell <ul style="list-style-type: none"> Used in compression/tension 17-4ph S.S. 28 AWG, 4 conductor shielded PVC cable, 10 ft 	 A = 0.98 in. (24.9 mm) B = 1.21 in. (30.7 mm) C = 0.33 in. (8.4 mm) D = 1/4-28 (M6x1)	Rated Output:..... 2 mV/V nom. Nonlinearity:..... ± 0.5% of RO Hysteresis:..... ± 0.5% of RO Operating Temperature:..... -45 to 200° F Excitation (max):..... 15 VDC Bridge Resistance:..... 700 Ω nom. Deflection:..... 0.001" nom. Wiring Code:..... WC1
LCM325 	2K, 3K lb. (9K, 13K N)	Miniature In-Line Load Cell <ul style="list-style-type: none"> Used in compression/tension Male/male threads 17-4ph S.S. 28 AWG, 4 conductor shielded PVC cable, 10 ft 	 A = 0.96 in. (24.4 mm) B = 1.50 in. (38.1 mm) C = 0.42 in. (10.7 mm) D = 3/8-24 (M10x1.5)	Rated Output:..... 1.3 to 2 mV/V nom. Nonlinearity:..... ± 0.5% of RO Hysteresis:..... ± 0.5% of RO Operating Temperature:..... -45 to 200° F Excitation (max):..... 18 VDC Bridge Resistance:..... 350 Ω nom. Deflection:..... 0.001" nom. Wiring Code:..... WC1
LCM350 	4K, 5K lb. (18K, 22K N)	Miniature In-Line Load Cell <ul style="list-style-type: none"> Used in compression/tension Male/male threads 17-4ph S.S. 28 AWG, 4 conductor shielded PVC cable, 10 ft External matched output option available 	 A = 0.96 in. (24.4 mm) B = 2.77 in. (70.4 mm) C = 0.90 in. (22.9 mm) D = 1/2-20 (M12x1.75)	Rated Output:..... 1.6 - 2 mV/V nom. Nonlinearity:..... ± 0.5% of RO Hysteresis:..... ± 0.5% of RO Operating Temperature:..... -45 to 200° F Excitation (max):..... 18 VDC Bridge Resistance:..... 350 Ω nom. Deflection:..... 0.002" nom. Wiring Code:..... WC1
LCM375 	7.5K, 10K lb. (33K, 44K N)	In-Line Load Cell <ul style="list-style-type: none"> Used in compression/tension Male/male threads 17-4ph S.S. 28 AWG, 4 conductor shielded PVC cable, 10 ft 	 A = 1.12 in. (28.4 mm) B = 2.77 in. (70.4 mm) C = 0.87 in. (22.1 mm) D = 3/4-16 (M16x2)	Rated Output:..... 1.5 - 2 mV/V nom. Nonlinearity:..... ± 0.5% of RO Hysteresis:..... ± 0.5% of RO Operating Temperature:..... -45 to 200° F Excitation (max):..... 18 VDC Bridge Resistance:..... 350 Ω nom. Deflection:..... 0.002" nom. Wiring Code:..... WC1

LCM Cylindrical Male/Male
 LCF Cylindrical Female/Female

Versioni ad elevata accuratezza
 TEDS opzione per tutti i modelli a catalogo. Fattori di carico estranei disponibile
 Visita www.futek.com oppure contatta il rappresentante locale











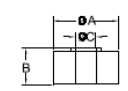

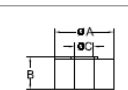
MODEL #	CAPACITIES	DESCRIPTION	DIMENSIONS	SPECIFICATIONS
 LCM500	2K, 5K lb. (9K, 22K N)	In-Line Load Cell <ul style="list-style-type: none"> Used in compression/tension 17-4ph S.S. 28 AWG, 4 conductor shielded PVC cable, 10 ft 	 A = 0.90 in. (22.9 mm) B = 3.0 in. (76.2 mm) C = 1.10 in. (27.3 mm) D = 1/2-20 (M12x1.75)	Rated Output: 2 mV/V nom. Nonlinearity: ± 0.2% of RO Hysteresis: ± 0.2% of RO Operating Temperature: -45 to 200° F Excitation (max): 18 VDC Bridge Resistance: 350 Ω nom. Deflection: 0.003" nom. Wiring Code: WC1
 LCM525	20K lb. (89K N)	In-Line Load Cell <ul style="list-style-type: none"> Used in compression/tension 17-4ph S.S. 28 AWG, 4 conductor shielded PVC cable, 10 ft External matched output option available 	 A = 1.25 in. (31.8 mm) B = 5.0 in. (127.0 mm) C = 2.10 in. (53.3 mm) D = 1-14 (M24x3)	Rated Output: 2 mV/V nom. Nonlinearity: ± 0.2% of RO Hysteresis: ± 0.2% of RO Operating Temperature: -45 to 200° F Excitation (max): 18 VDC Bridge Resistance: 350 Ω nom. Deflection: 0.004" nom. Wiring Code: WC1
 LCM550	50K lb. (222K N)	In-Line Load Cell <ul style="list-style-type: none"> Used in compression/tension 17-4ph S.S. 28 AWG, 4 conductor shielded PVC cable, 10 ft External matched output option available 	 A = 1.98 in. (50.3 mm) B = 6.0 in. (152.0 mm) C = 2.63 in. (66.7 mm) D = 1-1/2 (M36x4)	Rated Output: 2 mV/V nom. Nonlinearity: ± 0.2% of RO Hysteresis: ± 0.2% of RO Operating Temperature: -45 to 200° F Excitation (max): 18 VDC Bridge Resistance: 350 Ω nom. Deflection: 0.005" nom. Wiring Code: WC1
 LLB130	5, 10, 25, 50 lb. (22.2, 44.5, 111, 222 N)	Subminiature Load Button <ul style="list-style-type: none"> Used in compression Internal zero balance compensation Internal temperature shift zero compensation 17-4ph S.S. #34 AWG, 4 conductor Teflon® cable, S.S. Braided Shielded Cable 5 ft (1.5m) long 	 A = 0.38 in. (9.5 mm) B = 0.13 in. (3.3 mm) C = 0.09 in. (2.3 mm)	Rated Output: 2 mV/V nom. Nonlinearity: ± 0.5% of RO Hysteresis: ± 0.5% of RO Operating Temperature: -60 to 200° F Excitation (max): 7 VDC Deflection: 0.001" nom. Bridge Resistance: 350 Ω nom. Wiring Code: WC1
 LLB210	10, 25, 50 lb. (44, 111, 222 N)	Subminiature Load Button <ul style="list-style-type: none"> Used in compression Threaded button #2-56 17-4ph S.S. #29 AWG, 4 conductor shielded silicone cable, 10 ft 	 A = 0.38 in. (9.5 mm) B = 0.32 in. (8.1 mm) C = #2-56	Rated Output: 2 mV/V nom. Nonlinearity: ± 0.5% of RO Hysteresis: ± 0.5% of RO Operating Temperature: -60 to 200° F Excitation (max): 7 VDC Bridge Resistance: 350 Ω nom. Deflection: 0.001" nom. Wiring Code: WC1
 LLB215	10, 25, 50 lb. (44, 111, 222 N)	Subminiature Load Button <ul style="list-style-type: none"> Used in compression Vertical cable exit Threaded button #2-56 17-4ph S.S. #29 AWG, 4 conductor shielded silicone cable, 10 ft 	 A = 0.38 in. (9.5 mm) B = 0.50 in. (12.7 mm) C = 0.32 in. (8.1 mm) D = 0.20 in. (5.1 mm) E = #2-56	Rated Output: 2 mV/V nom. Nonlinearity: ± 0.5% of RO Hysteresis: ± 0.5% of RO Operating Temperature: -60 to 200° F Excitation (max): 7 VDC Bridge Resistance: 350 Ω nom. Deflection: 0.001" nom. Wiring Code: WC1
 LLB250	100, 150, 250 lb. (445, 667, 1112 N)	Subminiature Load Button <ul style="list-style-type: none"> Used in compression 17-4ph S.S. #29 AWG, 4 conductor shielded Teflon® cable, 5 ft 	 A = 0.50 in. (12.7 mm) B = 0.15 in. (3.9 mm) C = 0.12 in. (3.0 mm)	Rated Output: 2 mV/V nom. Nonlinearity: ± 0.5% of RO Hysteresis: ± 0.5% of RO Operating Temperature: -60 to 200° F Excitation (max): 7 VDC Bridge Resistance: 350 Ω nom. Deflection: 0.001" nom. Wiring Code: WC1
 LLB300	25, 50, 100, 250, 500, 1K lb. (111, 222, 445, 1112, 2224, 4K N)	Subminiature Load Button <ul style="list-style-type: none"> Used in compression 17-4ph S.S. #29 AWG, 4 conductor shielded Teflon® cable, 10 ft 	 A = 0.74 in. (18.8 mm) B = 0.25 in. (6.4 mm) C = 0.20 in. (5.1 mm)	Rated Output: 2 mV/V nom. Nonlinearity: ± 0.5% of RO Hysteresis: ± 0.5% of RO Operating Temperature: -60 to 250° F Excitation (max): 18 VDC Bridge Resistance: 700 Ω nom. Deflection: 0.001" nom. Wiring Code: WC1

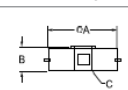
TEDS opzione per tutti i modelli a catalogo. Fattori di carico estranei disponibile
Visita www.futek.com oppure contatta il rappresentante locale

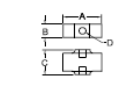
MODEL #	CAPACITIES	DESCRIPTION	DIMENSIONS	SPECIFICATIONS
LLB350 	25, 50, 100 lb. (111, 222, 445 N)	Subminiature Load Button • Used in compression • Threaded mounting holes #4-40 • 17-4ph S.S. • #29 AWG, 4 conductor shielded Teflon® cable, 10 ft	 A = 0.98 in. (24.9 mm) B = 0.32 in. (8.1 mm) C = 0.21 in. (5.3 mm) D = 0.75 in. (19.1 mm) E = #4-40	Rated Output: 2 mV/V nom. Nonlinearity: ± 0.5% of RO* Hysteresis: ± 0.5% of RO* Operating Temperature: -60 to 200° F Excitation (max): 18 VDC Bridge Resistance: 350 Ω nom. Deflection: 0.001" nom. Wiring Code: WC1
LLB400 	100, 250, 500, 1K, 2K, 2.5K lb. (445, 1112, 2224, 4K, 9K, 11K N)	Miniature Load Button • Used in compression • Threaded mounting holes #6-32 • 17-4ph S.S. • #26 AWG, 4 conductor shielded Teflon® cable, 10 ft	 A = 1.23 in. (31.2 mm) B = 0.39 in. (9.9 mm) C = 0.32 in. (8.1 mm) D = 1.00 in. (25.4 mm) E = #6-32	Rated Output: 2 or 2.5 mV/V nom. Nonlinearity: ± 0.15% 100-250 lb.; 0.25% 500-2K lb.; 0.5% 2.5K lb. of RO* Hysteresis: ± 0.15% 100-250 lb.; 0.25% 500-2K lb.; 0.5% 2.5K lb. of RO* Operating Temperature: -60 to 200° F Excitation (max): 18 VDC Bridge Resistance: 700 Ω nom. Deflection: 0.001" nom. Wiring Code: WC1
LLB450 	5K, 10K lb. (22K, 44K N)	Miniature Load Button • Used in compression • Threaded mounting holes #6-32 • 17-4ph S.S. • #24 AWG, 4 conductor shielded Teflon® cable, 10 ft	 A = 1.48 in. (37.6 mm) B = 0.63 in. (16.0 mm) C = 0.43 in. (10.9 mm) D = 1.25 in. (31.8 mm) E = #6-32	Rated Output: 2 mV/V nom. Nonlinearity: ± 0.5% of RO* Hysteresis: ± 0.5% of RO* Operating Temperature: -60 to 200° F Excitation (max): 18 VDC Bridge Resistance: 700 Ω nom. Deflection: 0.002" nom. Wiring Code: WC1
LLB500 	15K, 20K, 30K lb. (67K, 89K, 133K N)	Miniature Load Button • Used in compression • Threaded mounting holes #6-32 • 17-4ph S.S. • #24 AWG, 4 conductor shielded Teflon® cable, 10 ft	 A = 1.98 in. (50.3 mm) B = 1.00 in. (25.4 mm) C = 0.60 in. (15.2 mm) D = 1.625 in. (41.28 mm) E = #6-32	Rated Output: 2 mV/V nom. Nonlinearity: ± 0.5% of RO* Hysteresis: ± 0.5% of RO* Operating Temperature: -60 to 200° F Excitation (max): 18 VDC Bridge Resistance: 700 Ω nom. Deflection: 0.003" nom. Wiring Code: WC1
LLB550 	50K lb. (222K N)	Miniature Load Button • Used in compression • Threaded mounting holes #6-32 • 17-4ph S.S. • #24 AWG, 4 conductor shielded Teflon® cable, 10 ft	 A = 2.98 in. (75.7 mm) B = 1.50 in. (38.1 mm) C = 0.78 in. (19.8 mm) D = 2.375 in. (60.33 mm) E = #6-32	Rated Output: 2 mV/V nom. Nonlinearity: ± 0.5% of RO* Hysteresis: ± 0.5% of RO* Operating Temperature: -60 to 200° F Excitation (max): 18 VDC Bridge Resistance: 700 Ω nom. Deflection: 0.004" nom. Wiring Code: WC1
LTH300 	50, 100, 250, 500, 1K lb. (222, 445, 1112, 2224, 4K N)	Thru Hole Load Cell • Used in compression • 17-4ph S.S. • Inside diameter: 1/8 to 3/8" • #29 AWG, 4 conductor shielded Teflon® cable, 10 ft • High accuracy available	 A = 0.98 in. (24.9 mm) B = 0.28 in. (7.1 mm) C = 0.13-0.38 in. (3.3-9.7 mm)	Rated Output: 2 mV/V nom. Nonlinearity: ± 0.5% of RO* Hysteresis: ± 0.5% of RO* Operating Temperature: -60 to 200° F Excitation (max): 18 VDC Bridge Resistance: 700 Ω nom. Deflection: 0.001" nom. Wiring Code: WC1
LTH350 	100, 250, 500, 1K, 2K, 3K, 5K lb. (445, 1112, 2224, 4K, 9K, 13K, 22K N)	Thru Hole Load Cell • Used in compression • 17-4ph S.S. • Inside diameter: 1/8 to 5/8" • #24 AWG, 4 conductor shielded Teflon® cable, 10 ft • High accuracy available	 A = 1.48 in. (37.6 mm) B = 0.50 in. (12.7 mm) C = 0.13-0.63 in. (3.3-16mm)	Rated Output: 2 mV/V nom. Nonlinearity: ± 0.5% of RO* Hysteresis: ± 0.5% of RO* Operating Temperature: -60 to 200° F Excitation (max): 18 VDC Bridge Resistance: 700 Ω nom. Deflection: 0.002" nom. Wiring Code: WC1

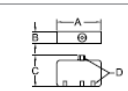
LCM Cylindrical Male/Male
LLB Load Button
LTH Thru-Hole/Donut

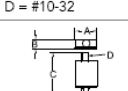

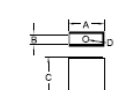











Versioni ad elevata accuratezza
TEDS opzione per tutti i modelli a catalogo. Fattori di carico estranei disponibile
Visita www.futek.com oppure contatta il rappresentante locale

MODEL #	CAPACITIES	DESCRIPTION	DIMENSIONS	SPECIFICATIONS
LTH400 	250, 500, 1K, 2K, 3K, 5K, 10K lb. (1K, 2K, 4K, 9K, 22K, 33K, 44K N)	Thru Hole Load Cell • Used in compression • 17-4ph S.S. • Inside diameter: 1/8 to 5/8" • #24 AWG, 4 conductor shielded Teflon® cable, 10 ft	 A = 1.98 in. (50.3 mm) B = 0.65 in. (16.5 mm) C = 0.13-0.63 in. (3.3-16mm)	Rated Output: 2 mV/V nom. Nonlinearity: ± 0.5% of RO* Hysteresis: ± 0.5% of RO* Operating Temperature: -60 to 200° F Excitation (max): 18 VDC Bridge Resistance: 700 Ω nom. Deflection: 0.002" nom. Wiring Code: WC1
LTH500 	2K, 3K, 5K, 7.5K, 10K, 15K, 20K, 30K, 50K lb. (9K, 13K, 22K, 33K, 44K, 67K, 89K, 133K, 222K N)	Thru Hole Load Cell • Used in compression • 17-4ph S.S. • Inside diameter: 1/8 to 1 1/4" • #24 AWG, 4 conductor shielded Teflon® cable, 10 ft	 A = 2.98 in. (75.7 mm) B = 1.00 in. (25.4 mm) C = 0.13-1.25 (3.3-31.8mm)	Rated Output: 2 mV/V nom. Nonlinearity: ± 0.5% of RO* Hysteresis: ± 0.5% of RO* Operating Temperature: -60 to 200° F Excitation (max): 18 VDC Bridge Resistance: 700 Ω nom. Deflection: 0.002" nom. Wiring Code: WC1
LTH900 	600K lb. (2669K N)	Thru Hole Load Cell • High capacity in-line used in compression • Dual bridge • Bendix receptacle: PT02E-10-6P with removable connector guard • Removable handles for transportation	 A = 12.95 in. (328.9 mm) B = 3.75 in. (95.3 mm) C = 4.80 in. (121.92 mm)	Rated Output: 3 mV/V nom. Nonlinearity: ± 0.2% of RO* Hysteresis: ± 0.2% of RO* Operating Temperature: -60 to 200° F Excitation (max): 20 VDC Deflection: 0.01" nom. Bridge Resistance: 350 Ω nom. Wiring Code: WC1
LRF350 	200, 300, 500, 1K lb. (890, 1334, 2K, 4K N)	Low Profile Load Cell • In-line loading in compression/tension • Female threads (both ends) • 2024 aluminum (150 to 300 lb.) • 17-4ph S.S. (500, 1k lb.) • 28 AWG, 4 conductor shielded Teflon® Shielded PVC, 10 ft. • Lemo® version standard. Cable version optional.	 A = 1.70 to 1.74 in. (43.2 to 44.2 mm) B = 1.01 in. (25.7 mm) C = 1.00 in. (25.4 mm) D = 3/8-24	Rated Output: 2 mV/V nom. Nonlinearity: ± 0.1% of RO Hysteresis: ± 0.1% of RO Operating Temperature: -60 to 200° F Excitation (max): 18 VDC Bridge Resistance: 350 Ω nom. Deflection: 0.002" nom. (0.006" nom. , 1K) Wiring Code: WC1, CC4
LRF400 	0.25 oz., 0.35 oz., 0.5 oz., 0.88 oz.; 1, 2, 2, 5, 10, 25, 50, 100 lb. (10g, 25g, 1.1, 2.2, 4, 9, 8, 22, 44, 111, 222, 445 N)	Low Profile Load Cell • In-line loading in compression/tension • Built-in Overload protection • Lemo® receptacle • 2024 aluminum	 A = 2.58 in. (65.4 mm) B = 0.96 in. (24.4 mm) C = 2.27 in. (57.7 mm) D = #10-32	Rated Output: 1-2 mV/V nom. Nonlinearity: ± 0.05% of RO, 10g ± 0.1% Hysteresis: ± 0.05% of RO Operating Temperature: -60 to 200° F Excitation (max): 18 VDC, 10g 5 VDC Bridge Resistance: 1000 Ω nom. Deflection: 0.003 to 0.011" nom. Wiring Code: CC4
LRM200 	3.5 oz., 8.8 oz.; 1, 2, 5, 10, 25, 50, 100 lb. (100g, 250g, 4, 9, 22, 44, 111, 222, 445 N)	S Beam Jr. with Male Threads • In-line loading in compression/tension • Built-in Overload protection • 2024 aluminum, 17-4ph S.S. 25-100 lb. • 29 AWG, 4 conductor shielded silicone cable, 5 ft	 A = 0.69 in. (17.5 mm) B = 0.26 in. (6.7 mm) C = 1.67 in. (42.4 mm) D = 1/4-28	Rated Output: 2 mV/V nom. Nonlinearity: ± 0.1% of RO Hysteresis: ± 0.1% of RO Operating Temperature: -60 to 200° F Excitation (max): 10 VDC Bridge Resistance: 350 - 1000 Ω nom. Deflection: 0.005" nom. Wiring Code: WC1
LSB200 	0.35 oz., 0.71 oz., 1.76 oz., 3.5 oz., 8.8 oz.; 1, 2, 5, 10, 25, 50, 100 lb. (10g, 20g, 50g, 100g, 250g; 4, 9, 22, 44, 111, 222, 445 N)	S-Beam Jr. Load Cell • In-line loading in compression/tension • Built-in Overload protection • 2024 aluminum, 17-4ph S.S. 25-100 lb. • 29 AWG, 4 conductor shielded silicone cable, 5 ft • Metric threads available (M3x0.5)	 A = 0.69 in. (17.5 mm) B = 0.26 in. (6.7 mm) C = 0.75 in. (19.1 mm) D = #4-40 (M3x0.5)	Rated Output: 0.5 - 2 mV/V nom. Nonlinearity: ± 0.1% of RO Hysteresis: ± 0.1% of RO Operating Temperature: -60 to 200° F Excitation (max): 10 VDC Bridge Resistance: 1000 Ω nom. 10 to 250 g. Deflection: 350 Ω nom. 1 to 100 lb. Deflection: 0.004-0.01" nom. Wiring Code: WC1

Versioni ad elevata accuratezza

TEDS opzione per tutti i modelli a catalogo. Fattori di carico estranei disponibile

Visita www.futek.com oppure contatta il rappresentante locale









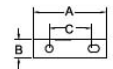

MODEL #	CAPACITIES	DESCRIPTION	DIMENSIONS	SPECIFICATIONS
LSB210 	100g, 250g, 1, 2, 5, 10, 25, 50, 100 lb. (1, 2.5, 4.5, 8.9, 22.2, 44.5, 111, 222, 445 N)	S-Beam Jr. Load Cell Submersible • In-line loading in compression/tension • Built-in Overload protection • 2024 aluminum, 17-4ph S.S. • 29 AWG, 4 conductor shielded silicone cable, 5 ft	 A = 0.63 in. (16.0 mm) B = 0.25 in. (6.4 mm) C = 0.75 in. (19.0 mm) D = 2 x #4-40 (M3x0.5)	Rated Output: 0.5 - 2 mV/V nom. Nonlinearity: ± 1 - 3% of RO Hysteresis: ± 1.5 - 5% of RO Operating Temperature: 0 to 160° F Excitation (max): 10 VDC Max Bridge Resistance: 350 Ω nom. Deflection: 0.005" nom. Wiring Code: WC1
LSB302 	25, 50, 100, 200, 300 lb. (111, 222, 445, 890, 1334 N)	S-Beam Load Cell • In-line loading in compression/tension • Built-in Overload protection • Anodized aluminum • 4 Pin Lemo® receptacle (standard) • Metric thread available • Submersible available	 A = 2.0 in. (50.8 mm) B = 0.5 in. (12.7 mm) C = 2.5 in. (63.5 mm) D = 1/4-28 (M6x1, M10x1.5)	Rated Output: 2 mV/V nom. Nonlinearity: ± 0.05% of RO Hysteresis: ± 0.05% of RO Operating Temperature: -60 to 200° F Excitation (max): 20 VDC Bridge Resistance: 1000 Ω nom. Deflection: 0.01" nom. Wiring Code: CC4, WC4
LSB350 	500, 1K, 2K lb. (2K, 4K, 9K N)	S-Beam Load Cell • In-line loading in compression/tension • 2 mV/V nom. rated output • Anodized aluminum, 17-4ph S.S. 2K lb. • 4 Pin Lemo® receptacle (standard) • Metric thread available	 A = 2.0 in. (50.8 mm) B = 1.12 in. (28.4 mm) C = 3.0 in. (76.2 mm) D = 1/2-20 (M12x1.75)	Rated Output: 2 mV/V nom. Nonlinearity: ± 0.1% of RO Hysteresis: ± 0.05% of RO Operating Temperature: -60 to 200° F Excitation (max): 20 VDC Bridge Resistance: 1000 Ω nom. Deflection: 0.015" nom. Wiring Code: WC4, CC4
LSB352 	500, 1K lb. (2K, 4K N)	S-Beam Load Cell • In-line loading in compression/tension • 3 mV/V nom. rated output • Built-in Overload protection • 17-4ph S.S.	 A = 2.00 in. (50.8 mm) B = 1.00 in. (25.4 mm) C = 3.00 in. (76.2 mm) D = 1/2-20	Rated Output: 3 mV/V nom. Nonlinearity: ± 0.05% of RO Hysteresis: ± 0.05% of RO Operating Temperature: -40 to 200° F Excitation (max): 18 VDC Bridge Resistance: 350 Ω nom. Deflection: 0.01" nom. Wiring Code: WC4
LSB400 	5K, 10K lb. (22K, 44K N)	S-Beam Load Cell • In-line loading in compression/tension • 17-4ph S.S. • 4 Pin Lemo receptacle, standard • 28 AWG, 6 conductor shielded polyurethane cable 5 ft (optional) • Metric thread available	 A = 2.45 in. (62.2 mm) B = 1.57 in. (39.9 mm) C = 3.5 in. (88.9 mm) D = 3/4-16 (M16x2)	Rated Output: 2 mV/V nom. Nonlinearity: ± 0.05% of RO Hysteresis: ± 0.05% of RO Operating Temperature: -60 to 200° F Excitation (max): 20 VDC Bridge Resistance: 350 Ω nom. Deflection: 0.01 to 0.02" nom. Wiring Code: WC4, CC4
LSB600 	10K, 25K lb. (44K, 111K N)	Cylindrical S-Beam Load Cell • In-line loading in compression/tension • Canister (cylindrical) design • 17-4ph S.S. • PT02E-10-6P with removable connector guard • Metric thread available • Dual-Bridge available	 A = 2.74 in. (69.6 mm) B = 4.75 in. (121.0 mm) C = 1 1/4-12 (M36x3)	Rated Output: 2 mV/V nom. Nonlinearity: ± 0.1% of RO Hysteresis: ± 0.1% of RO Operating Temperature: -60 to 200° F Excitation (max): 18 VDC Bridge Resistance: 350 Ω nom. Deflection: 0.005" nom. Wiring Code: CC1
FBB300 	1, 2, 5, 10, 20, 40 lb. (4, 9, 22, 44, 89, 178 N)	Force Sensor (OEM) • Bending Beam (planar beam) design • Full active bridge (300 series stainless steel) • Can be utilized to measure force, pressure, and displacement • Mounting kit required • 29 AWG, 4 conductor shielded silicone cable 12" long standard	 A = 1.25 in. (31.8 mm) B = 0.31 (7.8 mm) C = 0.75 (19.0 mm) D = 0.125 (3.18 mm)	Rated Output: 2 mV/V nom. Nonlinearity: Contact Factory Hysteresis: Contact Factory Operating Temperature: -60 to 200° F Excitation (max): 18 VDC Bridge Resistance: 1200 Ω nom. Deflection: 0.004 to 0.010" nom. Wiring Code: WC1

LTH Thru-Hole/Donut
LRF Rectangular Female/Female
LRM Rectangular Male/Male
FBB Bending Beam

FFP Flat Plate
LBB Bending Beam
LSB S-Beam/Z-Beam

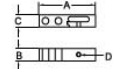
TEDS opzione per tutti i modelli a catalogo. Fattori di carico estranei disponibile

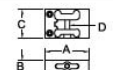
Visita www.futek.com oppure contatta il rappresentante locale

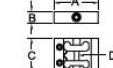
MODEL #	CAPACITIES	DESCRIPTION	DIMENSIONS	SPECIFICATIONS
FBB350 	1 oz., 0.25, 0.5, 1, 2, 20 lb. (0.278, 1.1, 2, 4, 9, 89 N)	Force Sensor (OEM) • Bending Beam (planar beam) design, • Full active bridge (300 series stainless steel, BeCu) • Can be utilized to measure force, pressure, and displacement • Mounting kit available • 29 AWG, 4 conductor shielded silicone cable 12" long standard	 A = 1.20 in. (30.5 mm) B = 0.25 in. (6.4 mm) C = 0.81 in. (21 mm)	Rated Output: 2 mV/V nom. Nonlinearity: Contact Factory Hysteresis: Contact Factory Operating Temperature: -60 to 200° F Excitation (max): 18 VDC Bridge Resistance: 1200 Ω nom. Deflection: 0.005" to 0.015" nom.. Wiring Code: WC1
FFP350 	1 lb. (4 N)	Flat Plate (OEM) • Full active bridge (300 series stainless steel) • As thin as 0.08" (2mm) • Can be utilized to measure force, pressure, and displacement • 29 AWG Teflon® wire, 6" long	 A = 0.95 in. (24 mm) B = 0.95 in. (24 mm) C = 0.05 in. (1.28 mm)	Rated Output: 1.5 mV/V nom. Nonlinearity: ± 0.25% of RO Hysteresis: ± 0.25% of RO Operating Temperature: -60 to 200° F Excitation (max): 10 VDC Bridge Resistance: 350 Ω nom. Deflection: Contact Factory Wiring Code: WC1
LBB200 	0.25, 0.5, 1, 2, 5, 10, 25 lb. (1, 2, 4, 9, 22, 44, 111 N)	Cantilever Bending Beam (OEM) • Can be utilized to measure force, pressure, and displacement • 28 AWG, 4 conductor shielded PVC cable, 1 ft • 17-ph S.S. • Exposed element	 A = 2.56 in. (65.0 mm) B = 0.28 in. (7.1 mm) C = 0.12-0.18 in. (3-4.6mm) D = 0.125 (3.18 mm)	Rated Output: 1 mV/V nom. Nonlinearity: ± 0.05% of RO Hysteresis: ± 0.05% of RO Operating Temperature: -45 to 200° F Excitation (max): 18 VDC Bridge Resistance: 1000 Ω nom. Deflection: 0.007 to 0.02" nom.. Wiring Code: WC3
LSM200 	10 lb. (44 N)	Fold Back Bending Beam (OEM) • Built-in overload protection • Side mounted • Exposed elements • 2024 aluminum • 2" Molex® flexible 4 conductor type A (1mm pitch) cable	 A = 1.75 in. (44.5 mm) B = 0.38 in. (9.7 mm) C = 0.36 in. (9.1 mm) D = #6-32	Rated Output: 2.3 mV/V nom. Nonlinearity: ± 0.2% of RO Hysteresis: ± 0.2% of RO Operating Temperature: -60 to 200° F Excitation (max): 18 VDC Bridge Resistance: 1000 Ω nom. Deflection: 0.004" nom.
LSM250 	0.25, 0.5, 1 lb. (1, 2, 4 N)	Parallelogram OEM Load Cell • Built-in overload protection up to 50 lb. • Side mounted • Exposed elements • 2024 aluminum • 29 AWG, 4 color coded Teflon® lead wires, 6" standard	 A = 1.49 in. (37.8 mm) B = 0.38 in. (9.7 mm) C = 0.93 in. (23.6 mm) D = #10-32	Rated Output: 2 mV/V nom. Nonlinearity: ± 0.05% of RO Hysteresis: ± 0.05% of RO Operating Temperature: -60 to 200° F Excitation (max): 18 VDC Bridge Resistance: 1000 Ω nom. Deflection: 0.004" nom. Wiring Code: WC2
LSM300 	2.2, 5, 10, 25, 50, 100, 200, 500 lb. (9.8, 22, 44, 111, 222, 445, 890, 2224 N)	Parallelogram OEM Load Cell • Built-in overload protection. • Side mounted • Used in tension/compression • 2024 aluminum, 17-ph S.S. (200-500 lb.) • 29 AWG, 4 color coded Teflon® lead wires, 6" standard	 A = 1.80 in. (45.7 mm) B = 0.50 in. (12.7 mm) C = 1.40 in. (35.6 mm) D = #10-32, 1/4-28	Rated Output: 2 mV/V nom. Nonlinearity: ± 0.02% to ± 0.06% of RO Hysteresis: ± 0.02% to ± 0.06% of RO Operating Temperature: -60 to 200° F Excitation (max): 18 VDC Bridge Resistance: 1000 Ω nom. Deflection: 0.006" nom. Wiring Code: WC2

Il meglio per l'ambiente.

FUTEK ha esaminato le direttive in dettaglio ed ha stabilito che tutti i prodotti offerti al momento sono conformi alla restrizione dell'uso della direttiva sulle sostanze pericolose (RoHS) e possono continuare ad essere venduti all'interno dell'Unione Europea senza violare la direttiva RoHS.

ROHS

TEDS opzione per tutti i modelli a catalogo. Fattori di carico estranei disponibile
Visita www.futek.com oppure contatta il rappresentante locale

www.futek.com

Contatti: +39 02 48 009 757

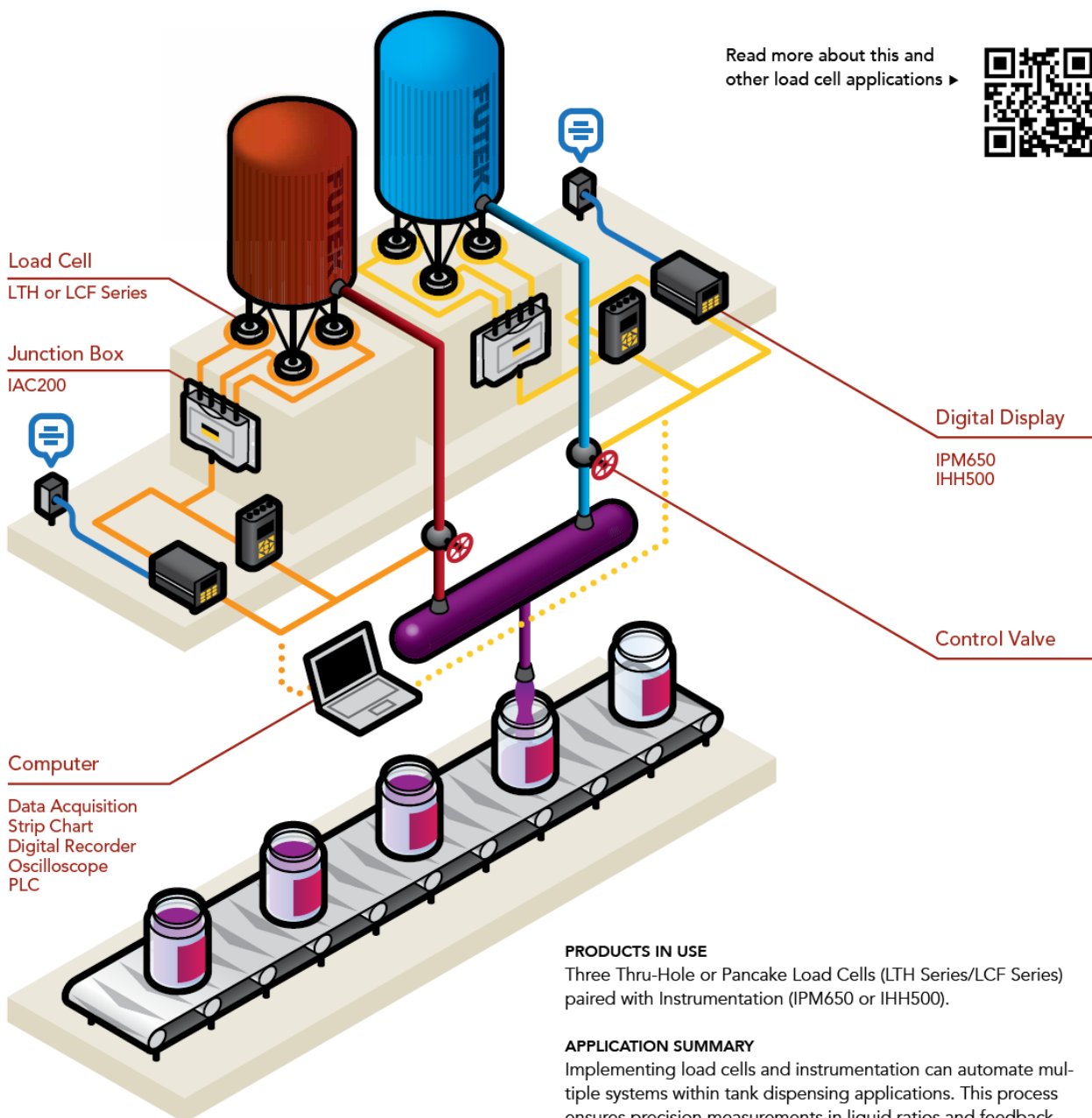

- FBB** Bending Beam
- FFP** Flat Plate
- LBB** Bending Beam
- LSB** S-Beam/Z-Beam

Tutte le illustrazioni sulle applicazioni sono concettuali
Prego contattarci per ogni esigenza

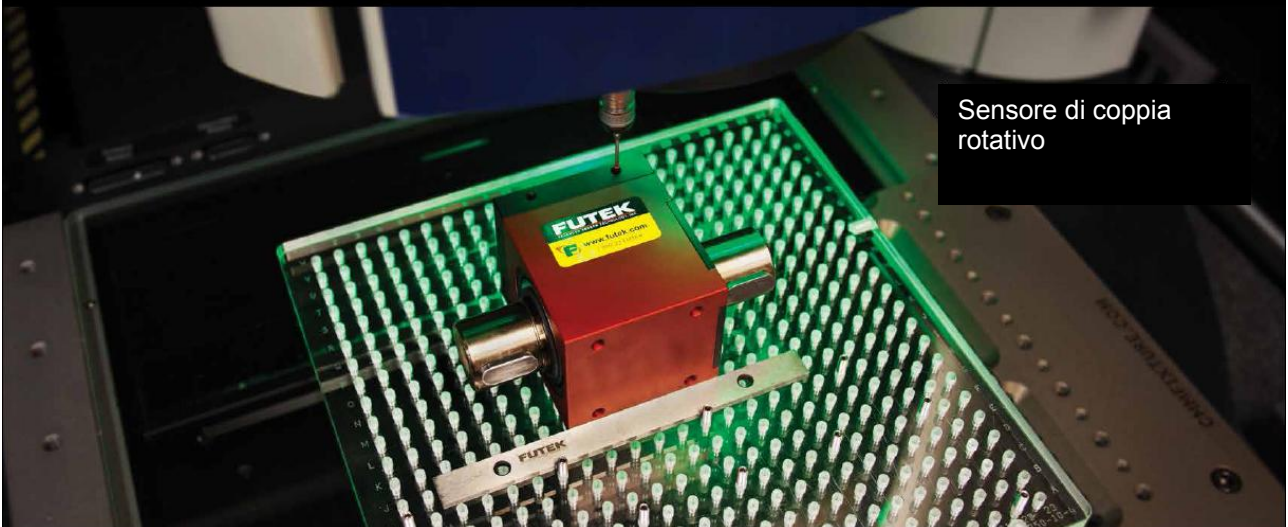

Nelle vasta gamma dei prodotti FUTEK c'è anche una serie impressionante di sensori a reazione torsionale e sensori per coppia rotanti.

I sensori per reazione di coppia FUTEK sono progettati per misurazioni statiche di torsione, mentre i nostri sensori di rotazione di coppia generano misurazioni dinamiche.

Entrambe le famiglie di sensori producono un segnale elettrico in uscita che può essere letto da qualsiasi dei nostri monitor digitali, amplificatori o in digitale mediante soluzioni USB.



Sensori a reazione di coppia

I sensori a reazione di coppia sono tipicamente usati per l'assenza di movimento, per applicazioni di misura in linea e revisione. Sapendo questo, abbiamo progettato queste serie di coppia in maniera versatile, affinché si possano scegliere diverse opzioni di montaggio, capacità diverse, e varie dimensioni dell'albero.

- Misure statiche
- Tecnologia estensimetrica
- Commerciale OEM
- Integrazione semplificata con la strumentazione

Sensori a coppia rotante





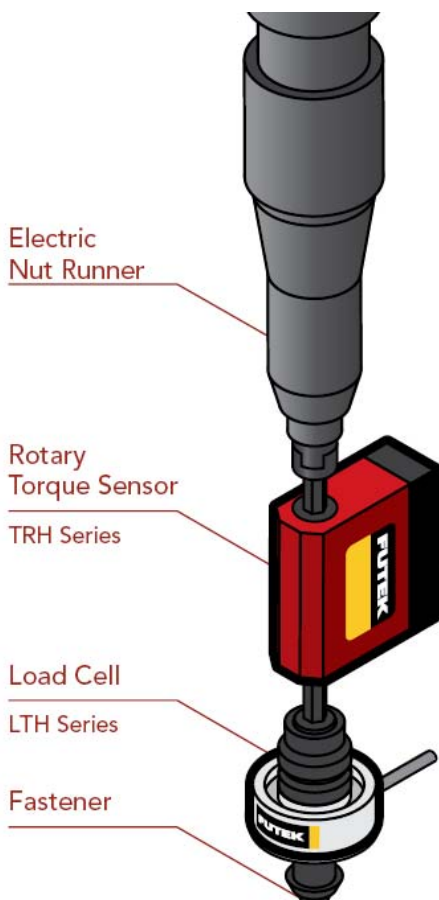





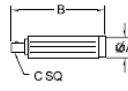

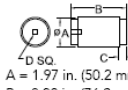

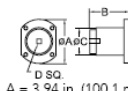
Con le opzioni del modello tra cui gli innesti quadri, esagonali e ad albero, gli ingegneri ed operatori trovano un sensore appropriato per soddisfare le loro specifiche. Questi sensori a coppia rotante sono particolarmente adatti per il settore aerospaziale, automobilistico, e per le applicazioni nella robotica.

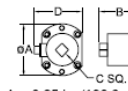
- uscite multiple - mV /V,VDC e USB
- portata fino a 5.000 Nm
- Fino a 50.000 RPM
- Opzioni Encoder

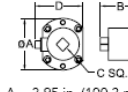

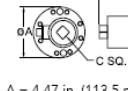
www.futek.com

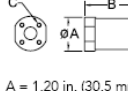
Contatti: +39 02 48 009 757

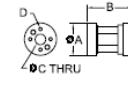









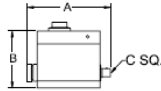

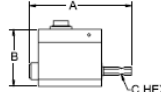
MODEL #	CAPACITIES	DESCRIPTION	DIMENSIONS	SPECIFICATIONS
TAT200 	50, 100 in-oz. (353, 706 Nmm)	Mini Screw Driver Reaction Torque Sensor • Reaction torque measurement in CW/CCW • Designed for torque auditing • Accepts moody's tool bits • 0.61" outside diameter • 28 AWG, 4 conductor braided shielded PVC cable, 10 ft long.	 A = 0.61 in. (15.4 mm) B = 2.75 in. (69.9 mm) C = 1/4 SQ Drive	Rated Output: 1 - 2 mV/V nom Nonlinearity: ± 0.2% of RO Hysteresis: ± 0.2% of RO Operating Temp: 0 to 160° F Excitation (max): 18 VDC Bridge Res: 1000 Ω nom. Wiring Code: WC1
TDD400 	5, 10, 20, 50, 160, 400, 1K in-oz.; 100, 200, 500 in-lb. (0.04, 0.08, 0.15, 0.37, 1.2, 3.0, 7.5, 12, 24, 60, Nm)	Reaction Torque Sensor • Square drive to square drive in CW/CCW • Built-in overload protection up to 400 in-oz • Aluminum construction • Quick disconnect Lemo® receptacle	 A = 1.97 in. (50.2 mm) B = 3.00 in. (76.2 mm) C = 0.50 in. (12.7 mm) D = 1/4 (5-1K in-oz), 3/8 (100-500 in-lb)	Rated Output: 1.5 - 2 mV/V nom. Nonlinearity: ± 0.2% of RO Hysteresis: ± 0.2% of RO Operating Temperature: -60 to 200° F Excitation (max): 18 VDC Bridge Resistance: 350 Ω - 700 Ω nom. Connector Code: CC4
TDF400 	5, 10, 20, 50, 160, 400, 1K in-oz.; 100, 200, 500 in-lb. (0.04, 0.08, 0.15, 0.37, 1.2, 3.0, 7.5, 12, 24, 60, Nm)	Reaction Torque Sensor with Flange • Flange to square drive in CW/CCW • Built-in overload protection up to 400 in-oz • Aluminum construction • Quick disconnect Lemo® receptacle	 A = 3.94 in. (100.1 mm) B = 3.00 in. (76.2 mm) C = 1.98 in. (50.2 mm) D = 1/4 (5-1K in-oz), 3/8 (100-500 in-lb)	Rated Output: 1.5 - 2 mV/V nom. Nonlinearity: ± 0.2% of RO Hysteresis: ± 0.2% of RO Operating Temperature: -60 to 200° F Excitation (max): 18 VDC Bridge Resistance: 350 Ω - 700 Ω nom. Connector Code: CC4
TDF600 	1.2K, 2.4K, 6K in-lb. (150, 300, 700 Nm)	Reaction Torque Sensor with Flange to Square • Square drive to flange in CW/CCW • 1/2" square drive (1.2K, 2.4 K in-lb), 3/4" square drive (6K in-lb) • 17-4 stainless steel, aluminum cover • Designed for auditing, calibrating mechanical torque wrenches, and used in automated assembly. • Amplified version available	 A = 3.95 in. (100.3 mm) B = 3.12-3.43 in. (79.4-87.1 mm) C = 0.50-0.75 in. (12.7-19.05 mm) D = 3.70 in. (94.0 mm)	Rated Output: 2 mV/V nom. Nonlinearity: ± 0.1% of RO Hysteresis: ± 0.1% of RO Operating Temperature: -60 to 200° F Excitation (max): 20 VDC Bridge Resistance: 700 Ω nom. Connector Code: CC1T, CC1
TDF650 	12K in-lb. (1.4K Nm)	Reaction Torque Sensor with Flange to Square • Square drive to flange in CW/CCW • 1" square drive • 17-4 stainless steel, aluminum cover • Designed for auditing, calibrating mechanical torque wrenches, and used in automated assembly. • Amplified version available	 A = 3.95 in. (100.3 mm) B = 3.62 in. (92.0 mm) C = 1.00 in. (25.4 mm) D = 3.70 in. (94.0 mm)	Rated Output: 2 mV/V nom. Nonlinearity: ± 0.1% of RO Hysteresis: ± 0.1% of RO Operating Temperature: -60 to 200° F Excitation (max): 20 VDC Bridge Resistance: 700 Ω nom. Connector Code: CC1T, CC1
TDF675 	24K in-lb. (2.7K Nm)	Reaction Torque Sensor with Flange to Square • Square drive to flange in CW/CCW • 1" square drive • 17-4 stainless steel, aluminum cover • Designed for auditing, calibrating mechanical torque wrenches, and used in automated assembly. • Amplified version available	 A = 4.47 in. (113.5 mm) B = 3.63 in. (92.0 mm) C = 1.00 in. (25.4 mm)	Rated Output: 2 mV/V nom. Nonlinearity: ± 0.1% of RO Hysteresis: ± 0.1% of RO Operating Temperature: -60 to 200° F Excitation (max): 20 VDC Bridge Resistance: 700 Ω nom. Connector Code: CC1T, CC1
TFF325 	20, 50 in-oz.; 12, 50, 100 in-lb. (141, 353 Nmm; 1.5, 6, 12 Nm)	Flange to Flange Reaction Torque Sensor • Aluminum construction • OEM version with exposed elements • Not recommended for end users • 29 AWG, 4 color coded Teflon® lead wires, 6" std. • Weight: 2.3 oz (65 g)	 A = 1.20 in. (30.5 mm) B = 2.00 in. (50.8 mm) C = #6-32	Rated Output: 2 mV/V nom. Nonlinearity: ± 0.2% of RO Hysteresis: ± 0.2% of RO Operating Temperature: -60 to 200° F Excitation (max): 18 VDC Bridge Resistance: 1000 Ω nom. Wiring Code: WC1
TFF350 	100, 150, 500, 1.3K, 3K in-lb. (11, 15, 60, 150, 339 Nm)	OEM Reaction Torque Sensor • Flange to flange in CW/CCW • 0.58" center thru-hole • Aluminum construction (up to 1300 in-lb) • 17-4 stainless steel construction (3000 in-lb) • 29 AWG, 4 color coded Teflon® lead wires, 6" std.	 A = 1.48 in. (37.59 mm) B = 2.00 in. (50.80 mm) C = 0.58 in. (14.73 mm) D = #10-32	Rated Output: 2 mV/V nom. Nonlinearity: ± 0.2% of RO Hysteresis: ± 0.2% of RO Operating Temperature: -60 to 200° F Excitation (max): 18 VDC Bridge Resistance: 700 Ω nom. Wiring Code: WC1

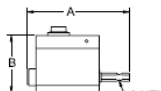
TAT Auditing Tool
TDD Drive/Drive
TDF Drive/Flange
TFF Flange/Flange

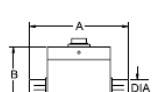
TEDS opzione per tutti i modelli a catalogo. Fattori di carico estranei disponibile
Visita www.futek.com oppure contatta il rappresentante locale

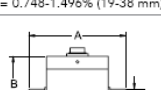
MODEL #	CAPACITIES	DESCRIPTION	DIMENSIONS	SPECIFICATIONS
TFF500 	100 in.-lb. (11.3 Nm)	Thru-Hole Reaction Torque Sensor • Flange to flange in CW/CCW • Anodized Aluminum • Thru-hole • TEDS • NEMA17 • Fits prime 017PLX Servo Motor	 A = 2.23 in. (56.64 mm) B = 0.75 in. (19.1 mm) C = 1.25 in. (31.8 mm)	Rated Output: ±1 mV/V nom., ±10 VDC Nonlinearity: ±0.5% of RO Hysteresis: ±0.5% of RO Operating Temperature: 0 to 160° F Excitation (max): 12-24 VDC1 to 18 Bridge Resistance: Contact Factory Wiring Code: Contact Factory
TFF400 	5, 10, 20, 50, 160, 400, 1K in.-oz., 100, 200, 500 in.-lb. (0.04, 0.08, 0.15, 0.37, 1.2, 3.0, 7.5, 12, 24, 60 Nm)	Reaction Torque Sensor • Flange to flange reaction in CW/CCW • Built-in overload protection up to 400 in-oz • Aluminum construction • Quick disconnect Lemo® receptacle • Optional mounting plates available	 A = 1.98 in. (50.2 mm) B = 2.00 in. (50.8 mm) C = 0.50-0.66 in. (12.8-16.8 mm) D = #8-32	Rated Output: 1 -2 mV/V nom. Nonlinearity: ±0.2% of RO Hysteresis: ±0.2% of RO Operating Temperature: -60 to 200° F Excitation (max): 18 VDC Bridge Resistance: 350 Ω - 700 Ω nom. Connector Code: CC4
TFF425 	5, 10, 20, 50, 160, 400, 1K in.-oz., 100, 200, 500 in.-lb. (0.04, 0.08, 0.15, 0.37, 1.2, 3.0, 7.5, 12, 24, 60 Nm)	Reaction Torque Sensor with Flanges • Flange to flange reaction in CW/CCW • Built-in overload protection up to 400 in-oz • Aluminum construction • Quick disconnect Lemo® receptacle	 A = 3.94 in. (100.1 mm) B = 3.00 in. (76.2 mm) C = 1.98 in. (50.2 mm)	Rated Output: 2 mV/V nom. (1 mV/V 5 in-oz) Nonlinearity: ±0.2% of RO Hysteresis: ±0.2% of RO Operating Temperature: -60 to 200° F Excitation (max): 18 VDC Bridge Resistance: 350 Ω - 700 Ω nom. Connector Code: CC4
TFF600 	1K, 2K, 5K, 10K in.-lb. (113, 225, 565, 1130 Nm)	Reaction Torque Sensor • Flange to flange reaction in CW/CCW • Aluminum construction (1K, 2K) • Steel construction (5K - 10K), aluminum cover • Quick disconnect Bendix® receptacle	 A = 4.46 in. (113.4 mm) B = 3.00 in. (76.2 mm) C = 0.56 in. (14.2 mm) D = 0.375 in. (9.53 mm)	Rated Output: 2 mV/V nom. Nonlinearity: ±0.2% of RO Hysteresis: ±0.2% of RO Operating Temperature: -60 to 200° F Excitation (max): 18 VDC Bridge Resistance: 350 Ω nom. Connector Code: CC1
TFF650 	20K, 50K, 100K in.-lb. (2260, 5650, 11.3K Nm)	Reaction Torque Sensor • Flange to flange reaction in CW/CCW • Steel construction, aluminum cover • Quick disconnect Bendix® receptacle • Amplified version available	 A = 6.71 in. (170.5 mm) B = 4.50 in. (114.3 mm) C = 1.00 in. (25.4 mm) D = 0.500-0.625 in. (12.70-15.88 mm)	Rated Output: 2 mV/V nom. Nonlinearity: ±0.5% of RO Hysteresis: ±0.5% of RO Operating Temperature: -60 to 200° F Excitation (max): 18 VDC Bridge Resistance: 350 Ω nom. Connector Code: CC1
TFF750 	240K, 300K in.-lb. (27.1, 33.9 Nm)	Reaction Torque Sensor • Flange to flange reaction in CW/CCW • Steel construction, aluminum cover • Quick disconnect Bendix® receptacle • Amplified version available	 A = 9.75 in. (247.7 mm) B = 8.50 in. (215.9 mm) C = 1.50 in. (38.1 mm) D = 0.625 in. (15.88 mm)	Rated Output: 2 mV/V nom. Nonlinearity: ±0.5% of RO Hysteresis: ±0.5% of RO Operating Temperature: -60 to 200° F Excitation (max): 18 VDC Bridge Resistance: 350 Ω nom. Connector Code: CC1
TSS400 	5, 10, 20, 50, 160, 400, 1K in.-oz., 100, 200, 500 in.-lb. (0.04, 0.08, 0.15, 0.37, 1.2, 3.0, 7.5, 12, 24, 60 Nm)	Reaction Torque Sensor with Shafts • Shaft to shaft reaction in CW/CCW • Aluminum construction • Quick disconnect Lemo® receptacle • Amplified version available • Note: Not a rotary sensor	 A = 1.97 in. (50.2 mm) B = 4.38 in. (111.1 mm) C = 0.94 in. (23.8 mm) D = 0.38 in. (9.7 mm)	Rated Output: 1.5 -2 mV/V nom. Nonlinearity: ±0.2% of RO Hysteresis: ±0.2% of RO Operating Temperature: -60 to 200° F Excitation (max): 18 VDC Bridge Resistance: 350 Ω - 700 Ω nom. Connector Code: CC4
TSS800 	120K in.-lb. (13.6K Nm)	Reaction Torque Sensor Shaft-to-Shaft • Male shaft with keyways measuring reaction in CW/CCW • 17-4 stainless steel construction • Amplified version available	 A = 4.98 in. (126.5 mm) B = 19.0 in. (482.0 mm) C = 3.0 in. (76.2 mm) D = 0.75 in. (19.1 mm)	Rated Output: 2 mV/V nom. Nonlinearity: ±0.5% of RO Hysteresis: ±0.5% of RO Operating Temperature: 0 to 200° F Excitation (max): 18 VDC Bridge Resistance: 350 Ω nom. Connector Code: CC1

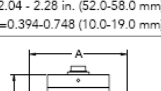
TEDS opzione per tutti i modelli a catalogo. Fattori di carico estranei disponibile
Visita www.futek.com oppure contatta il rappresentante locale

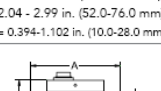
MODEL #	CAPACITIES	DESCRIPTION	DIMENSIONS	SPECIFICATIONS
 TRD605	106, 159, 443, 558, 885, 1328, 1416, 2213, 2655, 4425, 9K in-lb. (12, 18, 50, 63, 100, 150, 160, 250, 300, 500, 1K Nm)	Non-Contact Square Drive Rotary Torque Sensor with Encoder • Square Drive in CW/CCW • 12 nm, 18 nm: 1/4" drive, 2.95" overall length • 50 nm, 63 nm: 3/8" drive, 3.97" overall length • 100 nm, 150 nm, 160 nm: 1/2" drive, 4.17" overall length • 250 nm, 300 nm, 500 nm: 3/4" drive, 5.31" overall length • 1K nm: 1" drive, 6.97" overall length	 A = 2.95 - 6.97 in. (75.0-177 mm) B = 2.04 - 3.54 in. (52.0-90.0 mm) C = 1/4"-1"	Rated Output: ±5 VDC Nonlinearity: ± 0.2% of RO Hysteresis: ± 0.1% of RO Operating Temperature: -13 to 176° F Excitation (VDC or VAC): 11 to 26 Bridge Resistance: Contact Factory Rotational Speed (max): 7K RPM
 TRH300	18, 53, 106, 177 in-lb. (2, 6, 12, 20 Nm)	Slip Ring Hex Drive Rotary Torque Sensor • 1/4" Hex Drive in CW/CCW • Binder receptacle 09-0323-99-06	 A = 3.97 in. (101 mm) B = 2.04 in. (52 mm) C = 1/4"	Rated Output: 2 mV/V nom. (1 mV/V 2Nm) Nonlinearity: ± 0.2% of RO Hysteresis: ± 0.1% of RO Operating Temperature: -14 to 194° F Excitation (VDC or VAC): 5 to 11 Bridge Resistance: 350 Ω nom. Rotational Speed (max): 3K RPM
 TRH605	4.5, 9, 18, 53, 106, 159 in-lb. (0.5, 1, 2, 6, 12, 18 Nm)	Non-Contact Hex Drive Rotary Torque Sensor with Encoder • 1/4" Hex Drive in CW/CCW • Binder receptacle 09-0331-90-12	 A = 3.97 in. (101 mm) B = 2.04 in. (52.0 mm) C = 1/4"	Rated Output: ±5 VDC Nonlinearity: ± 0.2% of RO Hysteresis: ± 0.1% of RO Operating Temperature: -13 to 176° F Excitation (VDC or VAC): 11 to 26 Rotational Speed (max): 7K RPM Connector Code: Contact Factory
 TRS300	89, 177, 443, 885, 1770, 4425, 9K in-lb. (10, 20, 50, 100, 200, 500, 1K Nm)	Slip Ring Shaft-to-Shaft Rotary Torque Sensor • Shaft to Shaft Drive in CW/CCW • 10 Nm, 20 Nm, 50 Nm, 100 Nm: 0.748 DIA, 4.25" overall length • 200 Nm, 500 Nm, 1K Nm, 1.496 DIA, 7.16" overall length • Binder receptacle 09-0323-99-06	 A = 4.25 - 7.16 in. (108-182 mm) B = 2.28 - 3.54 in. (58-90 mm) DIA = 0.748-1.496% (19-38 mm)	Rated Output: 2 mV/V nom. Nonlinearity: ± 0.2% of RO Hysteresis: ± 0.1% of RO Operating Temperature: -14 to 194° F Excitation (VDC or VAC): 5 to 11 Bridge Resistance: 350 Ω nom. Rotational Speed (max): 3K RPM
 TRS600	9, 18, 44, 89, 177, 443, 885 in-lb. (1, 2, 5, 10, 20, 50, 100 Nm)	Non-Contact Shaft-to-Shaft Rotary Torque Sensor • Shaft to Shaft Drive in CW/CCW • 1, 2, 5, 10 Nm - 0.394 Dia, 3.62" overall length • 20, 50 Nm - 0.748 Dia., 4.25" overall length • 100Nm - 1.102 Dia., 4.92" overall length • Binder receptacle 09-0331-90-12	 A = 3.62 - 4.25 in. (92.0-108 mm) B = 2.04 - 2.28 in. (52.0-58.0 mm) DIA = 0.394-0.748 (10.0-19.0 mm)	Rated Output: ±5 VDC Hysteresis: ± 0.1% of RO Operating Temperature: -13 to 176° F Excitation (VDC or VAC): 11 to 26 Rotational Speed (max): 9K - 12K RPM Bridge Resistance: Contact Factory Connector Code: Contact Factory
 TRS605	9, 18, 44, 89, 177, 443, 885, 1770, 4425, 9K in-lb. (1, 2, 5, 10, 20, 50, 100, 200, 500, 1K Nm)	Non-Contact Shaft-to-Shaft Rotary Torque Sensor with Encoder • Shaft to Shaft Drive in CW/CCW • 1, 2, 5, 10 Nm - 0.394 Dia, 3.62 overall length • 20, 50 Nm - 0.630 Dia., 4.09 overall length • 100, 200 Nm - 1.102 Dia., 4.92 overall length • 500, 1K Nm - 1.654 Dia., 7.76 overall length	 A = 3.62 - 4.92 in. (92.0-125 mm) B = 2.04 - 2.99 in. (52.0-76.0 mm) DIA = 0.394-1.102 in. (10.0-28.0 mm)	Rated Output: ±5 VDC Nonlinearity: ± 0.2% of RO Hysteresis: ± 0.1% of RO Operating Temperature: -13 to 176° F Excitation (VDC or VAC): 11 to 26 Rotational Speed (max): 7K RPM Connector Code: Contact Factory
 TRS705	9, 18, 44, 89, 177, 443, 885, 1770, 4425, 9K in-lb. (1, 2, 5, 10, 20, 50, 100, 200, 500, 1K Nm)	Non-Contact Shaft-to-Shaft Rotary Torque Sensor with Encoder • 1, 2, 5, 10 Nm - 0.394 Dia, 3.54 overall length • 20, 50 Nm - 0.669 Dia., 4.17 overall length • 100, 200 Nm - 1.102 Dia., 4.92 overall length • 500, 1K Nm - 1.654 Dia., 7.76 overall length • 100 - 1000 Nm mounting frame is detachable	 A = 3.54 - 7.76 in. (90.0-197 mm) B = 3.27 - 6.52 in. (83.0-165.5 mm) DIA = 0.394-1.654 in. (10.0-42.0 mm)	Rated Output: ±5 VDC Nonlinearity: ± 0.2% of RO Hysteresis: ± 0.1% of RO Operating Temperature: -13 to 176° F Excitation (VDC or VAC): 11 to 26 Rotational Speed (max): 7K RPM Connector Code: Contact Factory

TFF Flange/Flange
TSS Shaft/Shaft
TRD Rotary Drive

TRH Rotary Hex Drive
TRS Rotary Shaft/Shaft

TEDS opzione per tutti i modelli a catalogo. Fattori di carico estranei disponibile
Visita www.futek.com oppure contatta il rappresentante locale

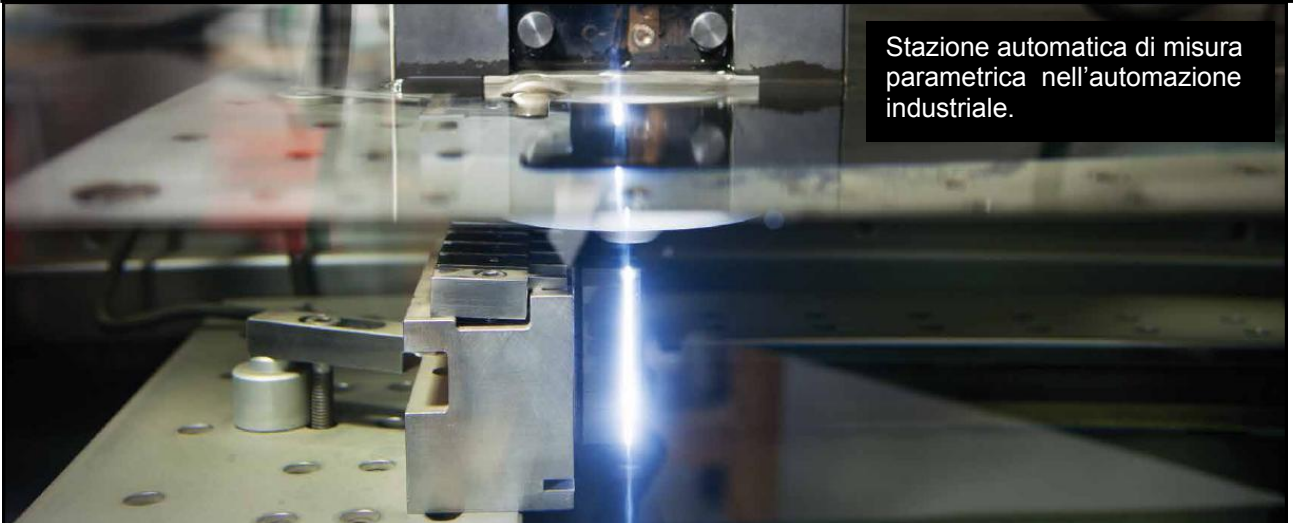

Stazione automatica di misura parametrica nell'automazione industriale.



FUTEK offre sensori di pressione di alta qualità per i settori industriali, aerospaziale, quello automobilistico e per l'industria produttiva in generale. Utilizzando la tecnologia estensimetrica, questi sensori di pressione misurano sia pressione relativa che pressione assoluta. Con oltre 350 prodotti unici derivanti da cinque famiglie di modelli, ingegneri e tecnici riusciranno a trovare la soluzione adeguata alle loro applicazioni.

CONTROLLO COMPLETO DELLE PRESSIONI IN UN SERBATOIO

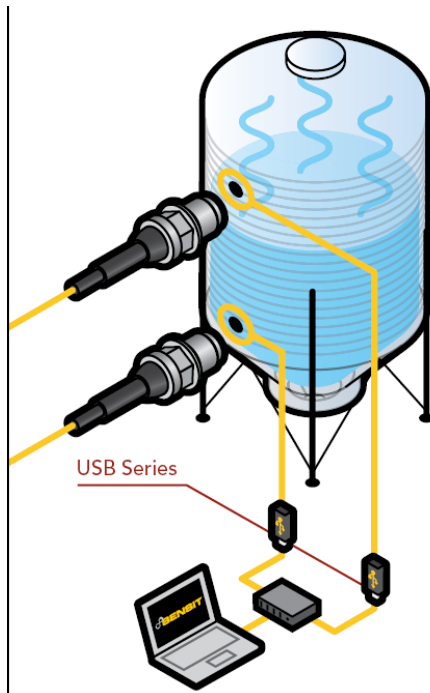







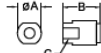

Solitamente i sensori di pressione FUTEK vengono utilizzati in molteplici ambienti dai test automobilistici ed aerospaziali, tra cui le prove motori, il sistema di raffreddamento e il sistema frenante.

Questi sensori vengono inoltre utilizzati per misurare la pressione differenziale all'interno di serbatoi, come viene mostrato in figura.

I sensori di pressione FUTEK sono compatibili con tutta la nostra gamma di strumenti come i display digitali, amplificatori e soluzioni USB. L'accoppiamento di questi sensori e strumenti con il software di prova e di misura SENSIT, gli utilizzatori sono in grado di raccogliere, registrare e trasformare a livello grafico i loro dati.

Funzionalità evidenziate

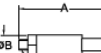
- Acciaio inossidabile delle parti bagnate
- Opzioni membrana affacciata
- Più opzioni di uscita: mV/V, 0-10V, 4-20mA e USB
- Modelli in miniatura
- OEM disegni di diverse versioni
- Elevata risposta in frequenza

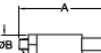
MODEL #	CAPACITIES	DESCRIPTION	DIMENSIONS	SPECIFICATIONS
PFP300 	300, 500, 1K, 3K, 5K, 7.5K, 10K psi (21, 34, 69, 207, 345, 517, 690 bar) OEM	Pressure Plug Sensor • 17-4 stainless steel • Unamplified output mV range • Pressure port: 1/4 NPT std. (optional 1/2-20) • 29 AWG, 4 color coded Teflon® lead wires, 6" std. • Weight: 2.5 oz (71 g)	 A = 0.97 in. (24.6 mm) B = 300-1K lb.: 0.90 in. (22.9 mm) 3-10K lb.: 1.19 in. (30.2 mm) *C = 1/4-18NPT *7/16-20 available	Combined Nonlin. & Hyst.: ± 1% RO Safe Overload: 150% RO Operating Temperature: -60 to 250° F Rated Output: 2 mV/V nom. Excitation (max): 18 VDC Bridge Resistance: 350 Ω nom. Wiring Code: WC1
PFP250 Series 	300, 500, 1K, 3K, 5K, 7.5K, 10K psi (21, 34, 69, 207, 345, 517, 690 bar) OEM	Pressure Sensor with Cable • 17-4 stainless steel • Unamplified output mV range • Pressure port: 1/4 NPT std. (optional 7/16-20) • 28 AWG, 4 conductor shielded Polyurethane cable, 3 ft standard. Quick disconnect Lemo® receptacle optional • Weight: 5.5 oz (156 g)	 A = 0.97 in. (24.6 mm) B = 2.00 in. (50.8 mm) *C = 1/4-18NPT *7/16-20 available * Amplified version available	Combined Nonlin. & Hyst.: ± 1% RO Safe Overload: 150% RO Operating Temperature: -60 to 250° F Rated Output: 2 mV/V nom. Excitation (max): 18 VDC Bridge Resistance: 350 Ω nom. Wiring Code: CC1, WC4, CC4
PFT510 	225, 750, 3K, 7.5K, 10K psi (15, 50, 200, 500, 700 bar)	Miniature Flush Mount Pressure Sensor • Stainless steel construction/Nema 4 (IP65) • Unamplified output mV range • Pressure port: M10x1 (optional 3/8-24) • 29 AWG, 4 conductor spiral shielded silicon cable, 5 ft • Weight is less than 10g without cable	 A = 0.55 in. (14.0 mm) B = 0.73 in. (19.0 mm) *C = M10 x 1 *3/8-24 available	Nonlinearity: ± 0.5% B.F.S.L. Hysteresis: ± 0.5% B.F.S.L. Safe Overload: 150% of RO Operating Temperature: -40 to 194° F Rated Output: 1 to 2 mV/V nom. Bridge Resistance: 350 Ω nom. Excitation Voltage: 7 MAX VDC Wiring Code: WC1
PMP300 	15, 25, 50, 100, 300, 500, 1K, 2K, 3K, 5K & 10K psi (1, 2, 3, 7, 21, 34, 69, 138, 207, 345, 690 bar)	OEM Pressure Sensor • Stainless steel/CE Conformity 89/337/ EWG-Interference Emissions and Immunity (EN 61 326) 9723/EG Pressure Equipment Directive • Pressure port: 1/4 NPT Male (optional 1/2 NPT, 7/16-20 Male available) • Available in 0-10 VDC • Absolute version available	 A = 2.40 in. (61.0 mm) B = 1.12 in. (28.5 mm) *C = 1/4 NPT Male *1/2 NPT, 7/16-20 Male available	Combined Nonlin. & Hyst.: Contact Factory Safe Overload: Contact Factory Rated Output RO: 0-10 VDC (4-20 mA available) Bridge Resistance: Contact Factory Operating Temperature: -40 to 176° F Excitation Voltage: 14-30 VDC (8-30 VDC for Voltage output) Wiring Code: Contact Factory
PMP450 	50 in. H2O, 5, 10, 25, 60, 100, 300, 500, 1K, 2K, 3K, 5K, 10K, 15K psi (0.125, 0.345, 0.690, 1.724, 4.138, 6.897, 20, 34, 68, 137, 206, 344, 689, 1034 bar)	Industrial Pressure Sensor • Stainless steel/CE Conformity 2004/108/EG EMC Directive EN 61 326 Emission Group 1, Class B Immunity Industrial Locations 97/23/EC Pressure Equipment Directive • Pressure port: 1/4 NPT Male (optional 1/2 NPT, 7/16-20 Male available) • Available in 0-10 VDC • Absolute version available	 A = 3.78 in. (96.0 mm) B = 1.06 in. (26.9 mm) *C = 1/4 NPT Male *1/2 NPT, 7/16-20 Male available	Combined Nonlin. & Hyst.: Contact Factory Safe Overload: Contact Factory Rated Output RO: 4-20 mA (0-10 VDC available) Bridge Resistance: Contact Factory Operating Temperature: -22 to 212° F Excitation Voltage: 10-30 VDC (14-30 VDC for Voltage output) Wiring Code: Contact Factory

LABORATORI DI INNOVAZIONE FUTEK

Come è risaputo, la tecnologia è sempre in espansione.

Nuovi progetti e soluzioni vengono sviluppati e introdotti quotidianamente. Questo è il bello di questo settore – l'incessante produzione di tecnologie innovative. Questi sono alcuni dei progetti ai quali FUTEK sta lavorando e che verranno introdotti sul mercato della prova e della misurazione entro l'anno prossimo:

- Funzionalità Ethernet
- Micro-Sensori di coppia
- LSB200 Incremento di capacità
- Sensori miniatura Multiasse

PFP Female Port
PFT Flush Mount Threaded
PMP Male Port



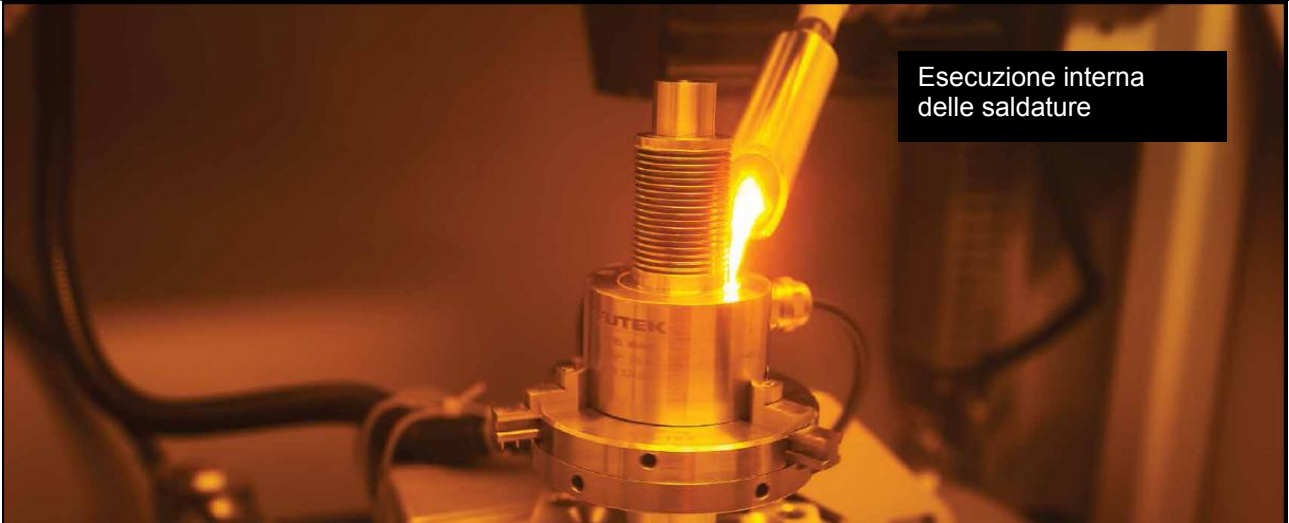

I sensori multiassiali possono misurare con precisione fino a sei componenti di forza/coppia (tre forze e tre momenti). Ad esempio: i ponti estensimetrici indipendenti sono utilizzati per misurare tre direzioni delle forze: longitudinale, laterale e verticale e i momenti di ciascuna direzione.

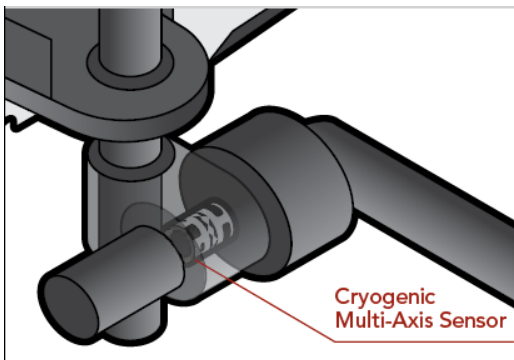

Un'attenta analisi strutturale della flessione monolitica è stata eseguita per isolare le forze e i momenti, che si traduce in una riduzione della sensibilità della diafonia. La serie di sensori multiassiali FUTEK misurano differenti configurazioni di carichi, coppia biassiale e tensione, carichi triassiali, multiassi a basso valore di spinta e momento, e il carico a sei assi e coppia. Comunemente usato in robotica e nelle applicazioni automobilistiche, i sensori multiassiali offrono un feedback simultaneo proveniente dal singolo sensore. Questi sensori non si limitano ad ambienti operativi, ma sono in grado di essere modificati per raggiungere condizioni più estreme quali le immersioni subacquee, amagnetiche e temperature criogeniche. FUTEK è altresì abile ad integrare l'elettronica (amplificatori o soluzioni USB) all'interno di molti sensori multiassiali.

Sign up.

Subscribe to our e-newsletter today, and receive tips, tricks, and FUTEK news right in your inbox.

Scan here to
subscribe ►



Funzionalità

- Estensimetri incapsulati
- Bassa diafonia
- Uscita mV / V
- Alta resistenza dei metalli
- Prodotto in USA
- Capacità 10-25.000 lbs

MODEL #	CAPACITIES	DESCRIPTION	DIMENSIONS	SPECIFICATIONS
 <p>MAU300</p>	10,25,50,100, 200 lb. (44, 111, 222, 445, 890 N)	Stick Shift/Gear Shift Knob Load Cell <ul style="list-style-type: none"> • Measure Fx and Fy loads • Anodized aluminum • Ergonomic cover w/ antislip notches • 28 AWG, 4 conductor shielded PVC cable, 10 ft. long 	 <p>A = 1.50 in. (38.1 mm) B = 3.00 in. (75.7 mm)</p>	Rated Output: 2 mV/V nom. Nonlinearity: ± 0.25% of RO Hysteresis: ± 0.25% of RO Operating Temperature: -40 to 160° F Excitation (max): 20 VDC Bridge Resistance: 350 Ω nom. Deflection: 0.002 to 0.009" nom. Wiring Code: WC1
 <p>MBA400</p>	50, 200 lb. (222, 890 N)	Bi-Axial Load Arm <ul style="list-style-type: none"> • Measure Fx and Fy loads • Lemo® receptacle • Mating connector and cable assembly available • Stainless Steel Construction 	 <p>A = 1.98 in. (50.3 mm) B = 3.32 in. (84.3 mm) C = 1.25 in. (31.8 mm)</p>	Rated Output: 2 - 3 mV/V nom. Nonlinearity: ± 0.1% of RO Operating Temperature: -60 to 200° F Excitation (max): 18 VDC Bridge Resistance: 350 Ω nom. Deflection: 0.01" nom. Wiring Code: CC4
 <p>MBA500</p>	Fz: 50-150, 200lb. Mz: 50-150, 200 lb. (222-667, 890 N; 5.6, 17, 23 Nm)	Torque and Thrust Bi-Axial Sensor <ul style="list-style-type: none"> • Aluminum construction • CW/CCW and tension/compression • 28 AWG, 4 conductor shielded PVC cable, 10 ft. (one for each axis) 	 <p>A = 1.98 in. (50.3 mm) B = 2.50 in. (63.5 mm) C = #8-32</p>	Rated Output: 2 - 3 mV/V nom. Nonlinearity: ± 0.25% of RO Hysteresis: ± 0.25% of RO Operating Temperature: -60 to 200° F Excitation (max): 18 VDC Bridge Resistance: 350 Ω nom. Deflection: 0.001" nom. Wiring Code: WC1
 <p>MTA400</p>	Fx, Fy: 250 lb.; Fz: 500 lb. (Fx, Fy: 1K N; Fz: 2K N)	Tri-Axial Sensor <ul style="list-style-type: none"> • Measures Fx, Fy, and Fz • Anodized aluminum • 10 pin Lemo® receptacle, mating connector available 	 <p>A = 2.95 in. (74.9 mm) B = 3.00 in. (76.2 mm)</p>	Rated Output (Fx, Fy): 1.5 mV/V nom. Rated Output (Fz): 0.75 mV/V nom. Nonlinearity: ± 0.25% of RO Hysteresis: ± 0.25% of RO Operating Temperature: -60 to 200° F Excitation (max): 18 VDC Bridge Resistance: 700 Ω nom. Wiring Code: CC8
 <p>MTA500</p>	Mx, My: 400, 800, 1K, 2K in-lb. Fz: 1K, 2K, 5K, 10K, 250K lb. (Mx, My: 45.2, 90.4, 113, 226 N-m) Fz: 4K, 9K, 22K, 44K, 1112K N-m)	Low-Profile Thrust and Moment Load Cell <ul style="list-style-type: none"> • Pancake sensor measuring thrust and moment • Measures Mx, My, Fz • Tension base included. • Anodized aluminum, 17-4ph S.S. • Bendix Connector PT02E-10-6P 	 <p>A = 4.13 in. (105 mm) B = 2.5 in. (63.4 mm) C = 5/8-18</p>	Rated Output (Mx, My): 0.5 to 1.5 mV/V nom. Nonlinearity (Mx, My): ± 0.5% of RO Nonlinearity (Fz): ± 0.2% of RO Crosstalk: 2.0% Operating Temperature: -60 to 200° F Excitation (max): 18 VDC Bridge Resistance: 350/700 Ω nom. Wiring Code: CC1
 <p>MTA505</p>	Mx, My: 2K, 10K in-lb. Fz: 10K, 25K lb. (Mx, My: 226, 1130 N-M Fz: 44K, 111K N)	Low Profile Thrust and Moment Load Cell <ul style="list-style-type: none"> • Pancake sensor measuring thrust and moment • Measures Mx, My, Fz • Tension base included. • 17-4ph S.S. • Bendix Connector PT02E-10-6P with removable connector guards 	 <p>A = 5.98 in. (151.9 mm) B = 3.50 in. (88.9 mm) C = 1 1/4-12</p>	Rated Output (Mx, My): 0.5 to 4 mV/V nom. Nonlinearity (Mx, My): ± 0.5% of RO Nonlinearity (Fz): ± 0.2% of RO Crosstalk: 2.0% Operating Temperature: -65 to 200° F Excitation (max): 18 VDC Bridge Resistance: 350 Ω nom. Wiring Code: CC1
 <p>MTA600</p>	Fx, Fy: 2.5K lb. Fz: 5K lb. (Fx, Fy: 11K N) (Fz: 22K N)	Tri-Axial Load Cell <ul style="list-style-type: none"> • Measures Fx, Fy, and Fz • 17-4ph S.S. • D-Sub 15-pin connector • 5/16-24 Flange Mounting Configuration 	 <p>A = 4.98 in. (126.5 mm) B = 3.50 in. (88.9 mm)</p>	Rated Output (Fx, Fy): 1.5 mV/V nom. Rated Output (Fz): 0.75 mV/V nom. Nonlinearity: ± 0.5% of RO Hysteresis: ± 0.5% of RO Operating Temperature: 0 to 160° F Excitation (max): 18 VDC Bridge Resistance (Fx, Fy): 350 Ω nom. Bridge Resistance (Fz): 700 Ω nom. Wiring Code: CC9
MHA400 - COMING SOON				
	Fx, Fy, Fz: 100 in-lb. Mx, My: 100 in-lb. Mz: 250 in-lb.	Low-Profile Six-Axis Sensor <ul style="list-style-type: none"> • Measures Fx, Fy, Fz, Mx, My, Mz • Aluminum construction • Robust and rigid design to reduce crosstalk errors • Flange mount design with #8-32 screws 	 <p>A = 4.5 in. (114 mm) B = 1.25 in. (31.8 mm)</p>	Rated Output (Fx, Fy, Fz, Mz): 1.5 mV/V nom. Rated Output (Mx, My): 2.0 mV/V nom. Nonlinearity: ± 0.25% of RO Hysteresis: ± 0.25% of RO Operating Temperature: -40 to 200° F Excitation (max): 18 VDC

MAU Multi Axis Automotive
 MBA Multi Dual Axis
 MTA Multi 3 Axis
 MHA Multi 6 Axis



FUTEK non produce solo celle di carico, di coppia, di pressione e dinamometri multiassi, bensì anche una intera gamma di strumenti e software.

Dai display digitali agli amplificatori universali e alle soluzioni USB, il nostro team di ingegneri ha progettato e sviluppato questa linea di strumentazione versatile ed efficiente. Molti degli strumenti FUTEK si integrano con i software SENSIT di misurazione, tutti progettati internamente presso la nostra sede.



MODELLO PALMARE
Modello IHH500 ► pag 34

Progettato con ingresso multiplo e opzioni di uscita, tra cui USB, ad alta precisione, registrazione dei dati, risoluzione interna a 24 bit, il modello IHH500 è adatto a ricevere fino a 4.800 campioni al secondo che lo rende una soluzione ideale per applicazioni portatili.



CONDIZIONATORE DA PANNELLO
Modello IPM650 ► pag 34

Questo condizionatore intelligente da pannello accetta sia mV/V e segnali amplificati sensori con uscita in un campo fino a ± 12 V o fino a 30 mA.

Con un menu di navigazione intuitivo, questo strumento elettronico è facile da implementare nella piattaforma del sensore.

Le soluzioni USB di FUTEK sono moduli esterni che fungono da interfacce digitali tra il sensore e il computer. Tradizionalmente, le piattaforme di misura consistevano in un sensore, un amplificatore, un filtro, un sistema di acquisizione dati ed un software per trasmettere a un computer. Le soluzioni USB di FUTEK eliminano la necessità di qualsiasi strumentazione supplementare, considerando la vostra piattaforma proprio dentro il sensore, il dispositivo USB ed il computer.

Prossimamente in arrivo nuove soluzioni USB

Il team di progettazione FUTEK è incentrato sulla realizzazione di soluzioni per tutte le circostanze di applicazione. Sia che la vostra piattaforma utilizzi una cella di carico o un sensore multiassiale, vogliamo che abbiate la strumentazione di feedback più efficiente possibile. Pertanto il nostro team di tecnici produce costantemente nuove soluzioni USB:

- USB240:
- USB520



Contatta il nostro ufficio vendite per maggiori informazioni sulle prossime uscite dei nostri aggiornamenti USB

FEATURES				
PARAMETER	USB210	USB220	USB320	USB410
USB 2.0 Communication Link	✓	✓	✓	✓
USB Bus-Powered (5V)	✓	✓	✓	✓
Integrated Shunt Cal	✓	✓		✓
Input /Output Short Circuit Protection	✓	✓	✓	✓
Quadrature Encoder Input				✓
ASCII	✓	✓	✓	✓
CE Approval	✓	✓	✓	✓
RoHS Compliant	✓	✓	✓	✓
SPECIFICATIONS				
PARAMETER	USB210	USB220	USB320	USB410
Sampling Rate (Samples Per Second)	Up to 1,000	Up to 4,800	Up to 4,800	Up to 200
Resolution	Up to 16 bits (ENOB)	Up to 19 bits (ENOB)	Up to 19 bits (ENOB)	Up to 18 bits (ENOB)
Internal Resolution	24 Bits	24 Bits	24 Bits	24 Bits
Nonlinearity	0.001% of FSR	0.001% of FSR	0.001% of FSR	0.001% of FSR
Accuracy	0.001% of FSR	0.001% of FSR	0.001% of FSR	0.001% of FSR
Temperature Coefficient Factor	10 ppm	10 ppm	10 ppm	10 ppm
Standard Input Range	±4 mV/V	±4 mV/V	±10 VDC (FSH03631)	±4 mV/V
Amplified Input	N/A	N/A	±10 VDC 0-20 mA*	N/A
Bridge Excitation	4.5 VDC	4.6 VDC	12 VDC ±0.5 / 1 W	4.5 VDC
Excitation Output	4.5 VDC	4.6 VDC	12 VDC**	4.5 VDC
Max. Bridge Resistance	5,000 Ω	5,000 Ω	N/A	5,000 Ω
Min. Bridge Resistance	50 Ω	50 Ω	N/A	50 Ω

*USB320 Does not support all of our amplified sensors due to power requirement.
**1W power output.

MODEL #	DESCRIPTION	INPUT	OUTPUT	SPECIFICATIONS
CSG110 	<ul style="list-style-type: none"> • Signal Conditioner • Multi Purpose Amplifier • Compatible with any full bridge strain gauge sensor • Power input: 14-26 VDC • Selectable Excitation: 5 VDC and 10 VDC • Interchangeable socket mounted shunt calibration with external shunt cal activation button • Din rail standard 	<ul style="list-style-type: none"> • ± 0.3 to ± 10 mV/V 	<ul style="list-style-type: none"> • ± 5 VDC, ± 10 VDC • 0-20 mA, 0-16 mA, 4-20 mA, 0-25 mA 	<ul style="list-style-type: none"> • CE Approval • RoHS Compliant • Internal span and offset potentiometers • Bandwidth: 1 kHz (standard), 10 kHz and 25 kHz (available) • Nonlinearity: $\pm 0.001\%$ of FSR • Selectable reverse polarity • Bipolar output, differential input
IHH500 	<ul style="list-style-type: none"> • IHH500 Intelligent Handheld Display • Multi purpose display • Compatible with any full bridge/strain gauge and most amplified output sensors (VDC, current) • Resolution: up to 22 Bits (ENOB) • 21K Point Data Logging • Excitation Output 5 VDC for Strain Gauge Only • 16 x 4 Character LCD/6 Digit Display • Bridge Resistance Measurement • Shunt Calibration • Universal Unit Conversion • 14 Sensor Profile Storage 	<ul style="list-style-type: none"> • Up to ± 500 mV/V (Strain Gauge) • Up to ± 12 VDC (Amplified output) • Up to 30 mA (Amplified output) • Leading and Lagging TLL input for encoders for Speed/Angle/Power Measurement (Elite Version only) 	<ul style="list-style-type: none"> • USB • ASCII Stream • 0-5 VDC or ± 5 VDC • 0-20 mA, 4-20 mA, 0-25 mA, 5-25 mA • Power Output 24 VDC / 1 W; 5 VDC / 0.25 W 	<ul style="list-style-type: none"> • Selectable Voltage & Current Configuration • Two Individual Relay Outputs • CE Approval • RoHS Compliant
IPM650 	<ul style="list-style-type: none"> • IPM650 Intelligent Panel Meter • Multi purpose display • Compatible with any full bridge/strain gauge and most amplified output sensors (VDC, current) • Resolution: up to 22 Bits (ENOB) • 21K Point Data Logging • Excitation Output 5 VDC for Strain Gauge Only • 16 x 4 Character LCD/6 Digit Display • Bridge Resistance Measurement • Shunt Calibration • Universal Unit Conversion • 14 Sensor Profile Storage 	<ul style="list-style-type: none"> • Up to ± 500 mV/V (Strain Gauge) • Up to ± 12 VDC (Amplified output) • Up to 30 mA (Amplified output) 	<ul style="list-style-type: none"> • USB • ASCII Stream • 0-5 VDC or ± 5 VDC • 0-20 mA, 4-20 mA, 0-25 mA, 5-25 mA • Power Output 24 VDC / 1 W; 5 VDC / 0.25 W 	<ul style="list-style-type: none"> • Selectable Voltage & Current Configuration • Two Individual Relay Outputs • CE Approval • RoHS Compliant

Made in U.S.A.

FUTEK progetta e produce i suoi sensori nel suo stabilimento di 20.000 mq che si trova ad Irvine, in California. FUTEK ha creato una capacità interna completa ed autonoma, dando ai membri del team FUTEK il pieno controllo circa la progettazione del prodotto, la produzione e la consegna, tutto questo garantendo la completa soddisfazione del cliente.



U.S. Manufacturer

SOFTWARE PER I TEST DI MISURAZIONE SENSIT

34

FUTEK ritiene che la vostra piattaforma per i test e la misurazione sia qualcosa di più che semplicemente un sensore più uno strumento. Una piattaforma dovrebbe includere anche un software che raccolga, trasformi in grafico ed interpreti i vostri dati.

Pertanto abbiamo sviluppato un software in grado di fare proprio questo. Presentare il software per i test di misura SENSIT: una piattaforma che espande le funzionalità tradizionale del sensore in una soluzione definitiva di test e misurazione.

Il software SENSIT è stato progettato e sviluppato dalla squadra di ingegneri FUTEK. Conoscendo le difficoltà di una catena di misura tradizionale, il nostro software è stato creato per eliminare tutti quei problemi e incertezze nelle misure e interpretazione dei dati.

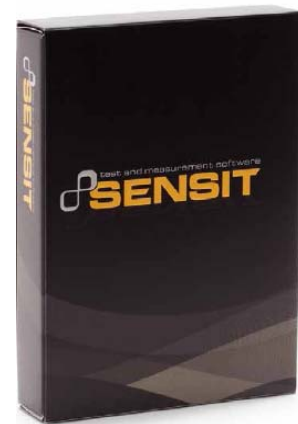

INTEGRAZIONE STRUMENTI

Il software SENSIT è progettato per funzionare senza problemi con tutte le soluzioni USB FUTEK, con il monitor a display, del palmare a indicazione digitali. Con questo software gli utenti hanno accesso a tutti i dati caricati e alle possibilità grafiche.



REGISTRAZIONE DEI DATI

Si può facilmente utilizzare il software SENSIT per misurare e monitorare con la classica "registrazione dati". Gli utenti possono configurare i loro test e registrare tutti i dati che si trovano nel software USB. Anche una soluzione di esportazione in Excel viene messa a disposizione rendendo questa funzionalità molto potente.



MATEMATICA $f(x)$

Necessità di eseguire alcuni calcoli? Approfitta dello strumento di calcolo per includere operazioni e funzioni. Questo strumento è molto utile per evitare errori di numerici.



RAPPRESENTAZIONE GRAFICA

Una delle grandi caratteristiche di SENSIT è la sua capacità di eseguire grafici in dinamica. Operando in modo parallelo con la funzione registrazione dati, la caratteristica grafica serve per l'analisi dell'andamento delle misure e come dati registrati in modo numerico.



16 CANALI

Il software SENSIT di FUTEK, è in grado di misurare l'attività di 16 diversi sensori della stessa piattaforma, di registrare i dati di ciascuno, oppure di attivare il display dei sensori che vuoi monitorare; indipendentemente dal funzionamento e controllo.



SEMPLICE CLICK, FACILE MENU

L'ambiente di visualizzazione SENSIT offre un "semplice click", una scorciatoia, che consente agli utenti la possibilità di accedere a modificare le impostazioni. Scegliere le frequenze di campionamento, cambiare le unità di conversione o accedere alle funzioni di base con un semplice click.



CONTROLLO REMOTO

FUTEK ha progettato il software SENSIT con la capacità in remoto di controllare le funzioni del IHH500 e IPM650 dal desktop del proprio computer.

Se un'applicazione richiede di effettuare delle modifiche, facilmente si programmano le impostazioni del IHH500 e IPM650 direttamente dalla scrivania.



COMPATIBILE CON LabVIEW

Gli Ingegneri di misura utilizzano un ampio numero di fonti software per eseguire le loro operazioni quotidiane. Conoscendo la popolarità del software LabVIEW National Instruments, puoi contare sul fatto che SENSIT viene offerto con un file di libreria a collegamento dinamico (DLL), usato per comunicare con LabVIEW

Download a free 14-day trial and updates to SENSIT Software ►



www.futek.com

Contatti: +39 02 48 009 757

DSPM Industria®
sensori & trasduttori

Via Paolo Uccello 4 - 20148 Milano
Tel +39 02 48 009 757 Fax +39 02 48 002 070

info@dspmindustria.it www.dspmindustria.it

www.futek.com

2	About FUTEK	12	Load Cells
3	Calibration Services	24	Torque Sensors
4	OEM Sensors	28	Pressure Sensors
6	Automotive Sensors	30	Multi-Axis Sensors
8	Aviation & Aerospace	34	Instruments
10	Medical Load Cells	35	Software



F11357

FUTEK reserves the right to modify its design and specifications without notice.
Please visit <http://www.futek.com/salesterms> for complete terms and conditions.

www.futek.com

www.futek.com

Contatti: +39 02 48 009 757

DSPM Industria®
sensori & trasduttori

Via Paolo Uccello 4 - 20148 Milano
Tel +39 02 48 009 757 Fax +39 02 48 002 070

info@dspmindustria.it
www.dspmindustria.it